

# **Dual Band SGH-P107 User Manual**

**Please read this manual before operating your phone,  
and keep it for future reference.**

Printed in Korea

GH68-04531A

English . 04/2004 . Rev. 1.0

## Intellectual Property

All Intellectual Property, as defined below, owned by or which is otherwise the property of Samsung or its respective suppliers relating to the SAMSUNG Phone, including but not limited to, accessories, parts, or software relating thereto (the "Phone System"), is proprietary to Samsung and protected under federal laws, state laws, and international treaty provisions. Intellectual Property includes, but is not limited to, inventions (patentable or unpatentable), patents, trade secrets, copyrights, software, computer programs, and related documentation and other works of authorship. You may not infringe or otherwise violate the rights secured by the Intellectual Property. Moreover, you agree that you will not (and will not attempt to) modify, prepare derivative works of, reverse engineer, decompile, disassemble, or otherwise attempt to create source code from the software. No title to or ownership in the Intellectual Property is transferred to you. All applicable rights of the Intellectual Property shall remain with SAMSUNG and its suppliers.

# **Samsung Telecommunications America (STA), Inc.**

## **U. S. Headquarters:**

1301 E. Lookout Drive  
Richardson, TX 75082  
Tel: 972-761-7000  
Fax: 972-761-7001

## **Customer Care Center:**

1601 E. Plano Parkway  
Suite 150  
Plano, TX 75047  
Tel: 888-987-HELP (4357)  
Fax: 972-761-7501

**Internet Address:** <http://www.samsungusa.com/wireless>

©2003 Samsung Telecommunications America. All rights reserved. No reproduction in whole or in part allowed without prior written approval. Samsung is a registered trademark of Samsung Electronics America, Inc. and its related entities.

|   |           |
|---|-----------|
| <b>Important Safety Precautions.....</b>    | <b>7</b>  |
| Road Safety at All Times .....              | 7         |
| Switching Off When Refueling .....          | 7         |
| Switching Off in Aircraft .....             | 7         |
| Switching Off in Hospitals.....             | 7         |
| Interference .....                          | 7         |
| Special Regulations .....                   | 7         |
| Radio Frequency Exposure .....              | 8         |
| Sensible Use .....                          | 8         |
| Emergency Call.....                         | 8         |
| Accessories and Batteries.....              | 8         |
| Qualified service .....                     | 8         |
| <br>  |           |
| <b>10 Driver Safety Tips .....</b>          | <b>9</b>  |
| <br>  |           |
| <b>Unpacking .....</b>                      | <b>13</b> |
| <br>  |           |
| <b>Your Phone .....</b>                     | <b>15</b> |
| Phone Layout .....                          | 15        |
| Display Layout.....                         | 19        |
| Service Light .....                         | 22        |
| <br>  |           |
| <b>Getting Started .....</b>                | <b>23</b> |
| Installing the SIM Card .....               | 23        |
| Charging a Battery .....                    | 25        |
| Switching the Phone On/Off.....             | 27        |
| <br>  |           |
| <b>Call Functions .....</b>                 | <b>29</b> |
| Making a Call.....                          | 29        |
| Adjusting the Volume .....                  | 31        |
| Answering a Call .....                      | 32        |
| Viewing Missed Calls.....                   | 33        |
| Switching Quickly to the Silent Mode .....  | 35        |
| <br>  |           |
| <b>Selecting Functions and Options.....</b> | <b>37</b> |

|   |           |
|---|-----------|
| Example: Setting the Display Language .....       | 39        |
| <b>Phonebook .....</b>                            | <b>41</b> |
| Storing a Number with a Name .....                | 41        |
| Using Phonebook Entry Options .....               | 44        |
| Searching for a Number in the Phonebook .....     | 45        |
| Editing a Caller Group.....                       | 47        |
| Speed-Dialing.....                                | 48        |
| Checking Memory Status.....                       | 50        |
| <b>Entering Text.....</b>                         | <b>51</b> |
| Changing the Text Input Mode .....                | 51        |
| Using the T9 Mode .....                           | 52        |
| Using the Upper/Lower-Case Character Mode.....    | 53        |
| Using the Symbol Mode .....                       | 55        |
| Using the Number Mode.....                        | 55        |
| <b>Options During a Call.....</b>                 | <b>57</b> |
| Putting a Call on Hold .....                      | 57        |
| Switching the Microphone Off (Mute) .....         | 58        |
| Muting/Sending DTMF.....                          | 59        |
| Sending DTMF Tones .....                          | 59        |
| Searching for a Number in the Phonebook .....     | 59        |
| Using the SMS Service .....                       | 60        |
| Answering a Second Call .....                     | 60        |
| Making a Multiparty Call.....                     | 61        |
| <b>Using the Menus .....</b>                      | <b>65</b> |
| Accessing Menu Functions by Scrolling .....       | 65        |
| Accessing Menu Functions by Using Shortcuts ..... | 66        |
| List of Menu Functions .....                      | 66        |
| <b>Text Messages .....</b>                        | <b>73</b> |
| Inbox .....                                       | 73        |
| Outbox .....                                      | 74        |

|                                 |           |
|---------------------------------|-----------|
| Write New .....                 | 75        |
| Templates.....                  | 77        |
| Settings.....                   | 78        |
| My Objects.....                 | 79        |
| Delete All.....                 | 80        |
| Memory Status .....             | 80        |
| Voice Mail .....                | 81        |
| Broadcast .....                 | 81        |
| <b>Multimedia Messages.....</b> | <b>83</b> |
| Inbox .....                     | 83        |
| Outbox .....                    | 86        |
| Shop MMS.....                   | 86        |
| Write New.....                  | 86        |
| Delete All.....                 | 89        |
| Setup.....                      | 89        |
| MMS Profile .....               | 89        |
| <b>Call Records.....</b>        | <b>91</b> |
| Missed Calls .....              | 91        |
| Incoming Calls.....             | 91        |
| Outgoing Calls.....             | 92        |
| Delete All.....                 | 92        |
| Call Time .....                 | 92        |
| <b>Camera .....</b>             | <b>93</b> |
| Take and Send .....             | 93        |
| New Photo .....                 | 94        |
| My Photos.....                  | 94        |
| <b>Sound Settings .....</b>     | <b>95</b> |
| Ring Tone .....                 | 95        |
| Ring Volume.....                | 95        |
| Shop Ringtones .....            | 95        |
| Alert Type.....                 | 95        |

|                              |            |
|------------------------------|------------|
| Keypad Tone .....            | 96         |
| Message Tone .....           | 96         |
| Folder Tone.....             | 97         |
| Power On/Off .....           | 97         |
| Extra Tones.....             | 98         |
| <b>Phone Settings .....</b>  | <b>99</b>  |
| Infrared Activate.....       | 99         |
| My Settings.....             | 100        |
| Greeting Message .....       | 102        |
| Own Number .....             | 102        |
| Language.....                | 102        |
| Security.....                | 103        |
| Display Settings.....        | 106        |
| Extra Settings .....         | 107        |
| ShortCut.....                | 108        |
| TTY Setting .....            | 109        |
| Reset Settings .....         | 110        |
| <b>Organizer .....</b>       | <b>111</b> |
| Calendar.....                | 111        |
| To Do List .....             | 113        |
| Time & Date.....             | 117        |
| Alarm .....                  | 118        |
| Calculator .....             | 119        |
| Currency Exchange .....      | 119        |
| <b>Network Services.....</b> | <b>121</b> |
| Call Forwarding.....         | 121        |
| Call Barring .....           | 122        |
| Call Waiting.....            | 124        |
| Network Selection .....      | 125        |
| Caller ID.....               | 126        |
| Closed User Group (CUG)..... | 126        |

|  |            |
|--|------------|
| <b>Funbox .....</b>                                    | <b>129</b> |
| Games .....  | 129        |
| WAP Browser.....                                       | 129        |
| Downloads .....  | 135        |
| <b>Solving Problems.....</b>                           | <b>137</b> |
| <b>Access Codes .....</b>                              | <b>141</b> |
| Phone Password.....                                    | 141        |
| PIN .....  | 142        |
| PUK .....  | 142        |
| PIN2 .....   | 143        |
| PUK2.....  | 143        |
| <b>Health and Safety Information .....</b>             | <b>145</b> |
| Exposure to Radio Frequency (RF) Signals .....         | 145        |
| For Body Operation .....                               | 146        |
| Precautions When Using Batteries .....                 | 147        |
| Road Safety .....                                      | 149        |
| Operating Environment.....                             | 151        |
| Electronic Devices .....                               | 151        |
| Potentially Explosive Environments.....                | 153        |
| Emergency Calls .....                                  | 154        |
| Other Important Safety Information .....               | 155        |
| Care and Maintenance .....                             | 156        |
| <b>Glossary .....</b>                                  | <b>159</b> |
| <b>Appendix A: Certification Information (SAR)</b>     | <b>163</b> |
| <b>Appendix B: Guide to Safe and Responsible Wire-</b> |            |
| <b>less Phone Use .....</b>                            | <b>165</b> |
| <b>A Guide to Safe and Responsible Wireless Phone</b>  |            |
| <b>Use.....</b>  | <b>165</b> |



**Appendix C: Consumer Update on Wireless Phones  
171**

**Standard Limited Warranty ..... 181**

**Index..... 187**

# Important Safety Precautions

Read these guidelines before using your wireless phone. Failure to comply with them may be dangerous or illegal. For more detailed safety information, see “Health and Safety Information”.

## Road Safety at All Times

Do not use a hand-held phone while driving; park the vehicle first.

## Switching Off When Refueling

Do not use the phone at a service station or near fuels or chemicals.

## Switching Off in Aircraft

Wireless phones can cause interference. Using them in an aircraft is both illegal and dangerous.

## Switching Off in Hospitals

Switch off your phone near medical equipment. Follow any regulations or rules in force.

## Interference

All wireless phones may be subject to interference, which could affect its performance.

## Special Regulations

Meet any special regulations in force in any area and always switch off your phone whenever it is forbidden to use it, or when it may cause interference or danger (in a hospital for example).

## **Radio Frequency Exposure**

The design of this phone complies with FCC (of the U.S. government) requirements relating to radio frequency (RF) exposure. To maintain compliance with these requirements, use only Samsung-supplied or approved accessories. Use of non-approved accessories may violate the requirements.

## **Sensible Use**

Use only in the normal position (held to the ear). Avoid unnecessary contact with the antenna when the phone is switched on.

## **Emergency Call**

Ensure the phone is turned on and in service.

Enter the emergency number for your present location, the press <SEND>. If certain features are in use, deactivate those features before you can make an emergency call. Give all necessary information as accurately as possible.

## **Accessories and Batteries**

Use only Samsung-approved accessories and batteries.

## **Qualified service**

Only qualified service personnel may install or repair your phone.

For more detailed safety information, see “Health and Safety Information” on page 145.

# 10 Driver Safety Tips

Your wireless telephone gives you the powerful ability to communicate by voice - almost anywhere, anytime. But an important responsibility accompanies the benefits of wireless phones, one that every user must uphold.

When driving a car, driving is your first responsibility. When using your wireless phone behind the wheel of a car, practice good common sense and remember the following tips:

1. Get to know your wireless phone and its features such as **speed dial and redial**. If available, these features help you to place your call without taking your attention off the road.
2. **When available, use a hands free device**. If possible, add an additional layer of convenience and safety to your wireless phone with one of the many hands free accessories available today.
3. **Position your wireless phone within easy reach**. Be able to access your wireless phone without removing your eyes from the road. If you get an incoming call at an inconvenient time, if possible, let your voice mail answer it for you.
4. **Let the person you are speaking with know you are driving; if necessary, suspend the call in heavy traffic or hazardous weather conditions**. Rain, sleet, snow, ice, and even heavy traffic can be hazardous.

5. **Do not take notes or look up phone numbers while driving.** Jotting down a “to do” list or flipping through your address book takes attention away from your primary responsibility, driving safely.
6. **Dial sensibly and assess the traffic; if possible, place calls when you are not moving or before pulling into traffic.** Try to plan calls when your car will be stationary. If you need to make a call while moving, dial only a few numbers, check the road and your mirrors, then continue.
7. **Do not engage in stressful or emotional conversations that may be distracting.** Make people you are talking with aware you are driving and suspend conversations that have the potential to divert your attention from the road.
8. **Use your wireless phone to call for help.** Dial 9-1-1 or other local emergency number in the case of fire, traffic accident or medical emergencies. Remember, it is a free call on your wireless phone!
9. **Use your wireless phone to help others in emergencies.** If you see an auto accident, crime in progress or other serious emergency where lives are in danger, call 9-1-1 or other local emergency number, as you would want others to do for you.
10. **Call roadside assistance or a special non-emergency wireless assistance number when necessary.** If you see a broken down vehicle posing no serious hazard, a broken traffic signal, a minor traffic accident where no one appears injured, or a vehicle you

know to be stolen, call roadside assistance or other special non emergency number.

“The wireless industry reminds you to use your phone safely when driving.”

For more information, please call 1-888-901-SAFE, or visit our website [www.wow-com.com](http://www.wow-com.com)™

Provided by the Cellular Telecommunications & Internet Association



# Unpacking

Your package contains the following items.



Handset

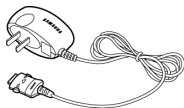

Travel Adapter



Battery



User Guide



Hand Strap

In addition, you can obtain the following accessories for your phone from your local Samsung dealer:

- Battery charger
- Hands-free headset



- Simple hands-free kit
- Standard battery
- Car power charger
- Leather case



# Your Phone



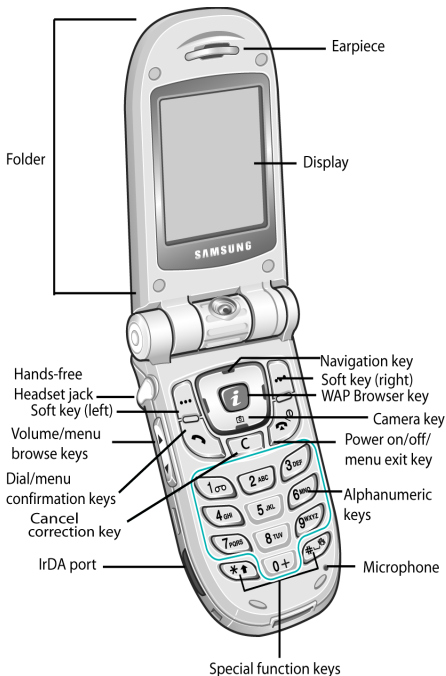

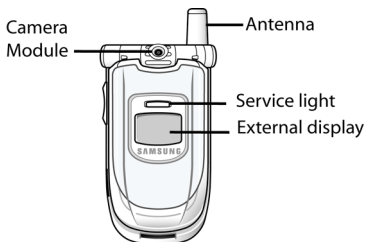
## Phone Layout



The following illustrations show the main elements of your phone.





| Key   | Description   |
|---|---|
|    | <p>In the Menu Mode, scroll through the menu options and phonebook memory.</p> <p>In idle mode, allow you to access your favorite menu options directly (for more information on shortcuts, see See “ShortCut” on page 108.).</p>   |
|  | <p>In the menu facility, returns to the previous menu level and select the current menu respectively.</p> <p>When entering text, move the cursor left and right respectively.</p> <p>In idle mode, allows you to access your favorite menu options directly (for more information on shortcuts, see See “ShortCut” on page 108.).</p> |

| Key  | Description   |
|--|---|
| <br>(soft keys) | Perform the functions indicated by the text above them (on the bottom line of the display).   |
|                 | In idle mode, launches the WAP Browser directly.  |
|                 | Deletes characters from the display.<br><br>In the menu facility, returns to the previous menu level.   |
|                 | Makes or answers a call.<br><br>When held down in idle mode, recalls the last numbers dialed or received.<br><br>In the menu facility, selects a menu function or stores information that you have entered (such as a name) in the phone or SIM memory. |
|               | Ends a call. Also switches the phone on and off when held down for 2 or more seconds.<br><br>In the menu facility, returns to the idle mode and cancels your input.   |

| Key   | Description   |
|---|---|
|  | <p>When held down for 3 or more seconds in idle mode, accesses your voice mail.</p>   |
|  | <p>Enter numbers, letters and some special characters.</p>  |
|  | <p>(on the side of the phone)<br/>           During a call, adjust the earpiece volume.</p> <p>In idle mode, adjust the key volume.</p> <p>In the menu facility, scroll through the menu options and phone book memory.</p> |





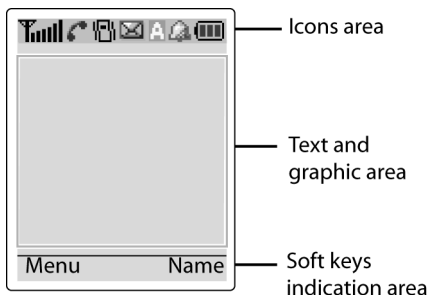

## Display Layout



The display is comprised of three areas.



| Area         | Description   |
|--------------|---|
| First line   | Displays various icons (see “Icons” on page 20).  |
| Middle lines | Display messages, instructions and any information that you enter (number to be dialed, for example). |
| Last line    | Shows the functions currently assigned to the two soft keys.  |

## Icons

| Icon  | Description  |
|---|--|
|    | Shows the received signal strength. The greater the number of bars, the better the signal strength.  |
|    | Appears when a call is in progress.  |
|    | Appears when you are connected to the GPRS network.  |
|    | Appears when the Silent mode is active or you set the <b>Alert Type</b> menu option, so that the phone vibrates when you receive a call; for further details, see “Alert Type” on page 95. |
|    | Appears when a new text message has been received.   |
|  | Appears when a new voice mail message has been received.   |
|  | Appears when you are entering text to indicate the current text input mode.  |

| Icon  | Description   |
|---|---|
|  | Appears when you set the alarm.   |
|  | Shows the level of your battery. The more bars you see, the more power you have left. |
|  | Appears when the Mute mode is active.   |

## Backlight

The display is illuminated by a backlight. When you press any key, the backlight illuminates. It turns off if no key is pressed within a given period of time, depending on the **Back Light** menu option.

To specify the length of time for which the backlight is active, set the **Back Light** menu option (**Menu 6.7.2**).

You can also set the phone to use the backlight only during a specified period time, via the **Auto Light** menu option.

## External Display

Your phone has an external display on the cover. It indicates that you have an incoming call or a message, and notifies you when you set an alarm at the specified time.



## Main Screen Display

Your phone has a main screen display. It indicates that you have an incoming call or a message, and notifies you at the specified time when you set an alarm.

## Service Light

The service light is above the external display on the folder cover. It flashes when services are available on the phone. To activate or deactivate use of the service light, set the **Service Light** menu option (**Menu 6.7.4**).



# Getting Started

## Installing the SIM Card

When you subscribe to a cellular network, you are provided with a plug-in SIM card loaded with your subscription details, such as your PIN, and any optional services available.

**Note:** The plug-in SIM card and its' contacts can be easily damaged by scratches or bending, so be careful when handling, inserting or removing the card. Keep all SIM cards out of reach of small children.

11.If necessary, turn the phone off by holding down the  key until the power-off image is displayed.

12.Remove the battery. To do so:

- Press down the catch above the battery and hold it in this position.
- Slide the battery and lift it away, as shown.

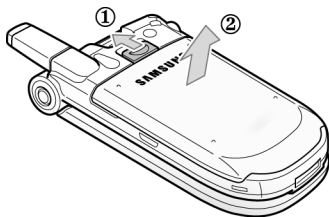

13.Slide the SIM card into the SIM card holder so that the holder locks the card in position. Make sure that the

notched corner is at top left and the gold contacts of the card face into the phone.

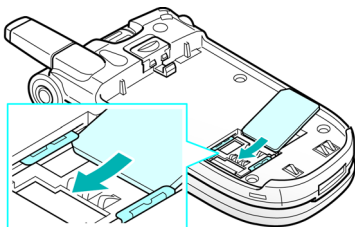

**Note:** When you need to remove the SIM card, slide it, as shown, and take it out of the holder.

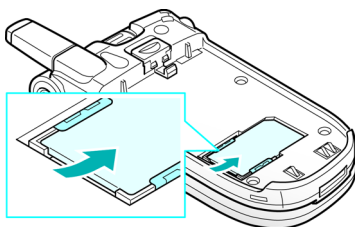

14. Place the battery back, taking care to match the tabs on the battery with the grooves on the phone.

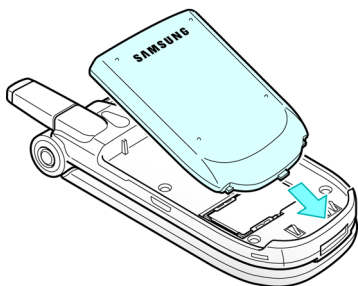

15. Slide the battery towards the top of the phone until it clicks into place. Make sure that the battery is properly installed before switching on the power.

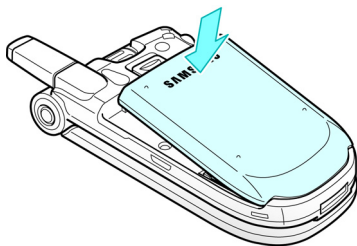

## Charging a Battery

Your phone is powered by a rechargeable Li-ion battery. A travel adapter is provided with your phone. Use only approved batteries and chargers. Ask your local Samsung dealer for further details.

The phone can be used while the battery is charging, but this will cause the phone to charge more slowly.

**Note:** You must fully charge the battery before using your phone for the first time. A discharged battery is fully recharged in approximately 160 minutes.

1. With the battery in position on the phone, connect the lead from the travel adapter to the bottom of the phone.

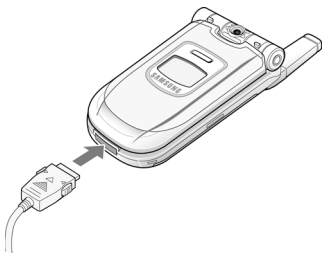

2. Connect the adapter to a standard AC wall outlet.
3. When charging is finished, disconnect the adapter from the power outlet and from the phone by pressing the gray tabs on both sides of the connector and pulling out the connector.

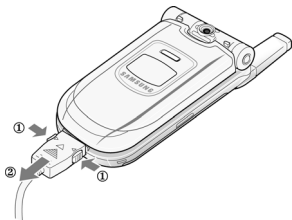

**Note:** Do not remove the battery from the phone without unplugging the adapter while it is charging. If you do this, the phone may be damaged.

## Low Battery Indicator

When the battery is weak and only a few minutes of talk time remain, you will hear a warning tone and a message will be repeated at regular intervals on the display:



When the battery becomes too weak for the phone to operate, it switches off automatically.

## Switching the Phone On/Off

1. Open the folder.
2. Hold down the  key until the phone turns on.
3. If the phone asks for a password, key in the password and press the **OK** soft key. The phone password is factory set to 00000000. For further details, see “Phone Password” on page 141.

4. If the phone asks for a PIN, key in the PIN and press the **OK** soft key. For further details, see “PIN” on page 142.

The phone searches for your network and when it finds it, the idle screen, illustrated below, appears on each display. Now, you can make or receive a call.

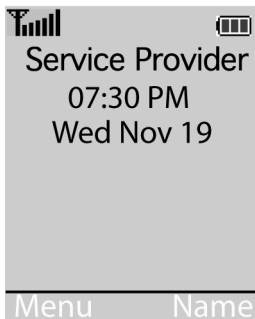

**Note:** The display language is factory set to English. To change the language, use the Language menu option (**Menu 6.5**).

5. To turn off the phone, hold down the  key until the power-off image is displayed.



# Call Functions

## Making a Call

When the idle screen is displayed, key in the area code and phone number, and press the  key.





**Note:** If you have checked the Auto Redial option in the Extra Settings menu (**Menu 6.8.1**), the number is redialed automatically up to ten times when the person does not answer the call or is already on the phone; see “Extra Settings” on page 107 for further details.

## Making an International Call

1. Press and hold down the  key.  
The + character appears.
2. Key in the country code, area code and phone number and press the  key.



## Correcting the Number

| To clear...                   | Then...  |
|-------------------------------|--|
| The last digit displayed      | Press the  key.   |
| Any other digit in the number | Press the  or  key until the cursor is immediately to the right of the digit to be cleared. Press the  key. You can also insert a missing digit simply by pressing the appropriate key. |
| The whole display             | Hold down the  key for more than one second.  |

## Ending a Call



When you have finished your call, briefly press the  key.

## Redialing the Last Number

The phone stores the numbers you dialed, received or missed.

To recall any of these numbers, proceed as follows.

1. If you have typed any characters on the display, clear the display by holding down the  key for more than one second.

2. Press the  key to display a list of the last numbers in the order in which the calls were made.
3. Use the  and  keys to scroll through the numbers until the required number is highlighted.

#### 4.To...

dial the number highlighted

edit the number highlighted

delete the number highlighted

#### Then...

press the  key.



press the **Options** soft key select **Edit Number** option and change the number as required.

press the **Options** soft key and select **Delete**.

## Making a Call from the Phonebook

You can store frequently-dialed phone numbers with a name in the SIM card or the phone memory, using the phonebook. You then simply select the required name to recall the associated number. For further details on the Phonebook features, see “Phonebook” on page 41.

## Adjusting the Volume

During a call, if you want to adjust the earpiece volume, use the UP and Down keys on the left side of the phone. Press the  key to increase and the  key to decrease the volume.

In idle mode, you can adjust the key volume using the ▲ and ▼ keys.

## Answering a Call

When somebody calls you, the phone rings and the following screen appears on each display.



If stored in your phonebook, the caller's phone number or name displays.

1. Open the folder and press the  key or the **Accept** soft key to answer the incoming call.

If the Anykey Answer option in the **Extra Settings** menu (**Menu 6.8.3**) is checked, you can press any key to answer a call except for the  key and the **Reject** soft key.

If the **Active Folder** option in the **Extra Settings** menu is checked, you can answer the call simply by opening the folder.

**Note:** To reject an incoming call, press and hold the volume keys on the left side of the phone before opening the folder.

2. End the call by pressing the  key.

**Note:** You can answer a call while using the phonebook or menu features.

## Viewing Missed Calls



If you are unable to answer a call, you can find out who was calling you, provided that this service is available to you.

The number of missed calls is displayed on the idle screen immediately after a call was missed.

To view the missed call immediately

1. Open the folder and press the **View** soft key.



The number corresponding to the most recent missed call is displayed, if available.

| To....                          | Then press the...   |
|---------------------------------|---|
| scroll through the missed calls |  or  key. |
| call the number displayed       |  key.  |

## Editing a Missed Call Number



If the number corresponding to the missed call is not available, the **Edit Number** option is not displayed.

1. Press the **Options** soft key.

2. Press the  or  key to highlight the **Edit** option.
3. Press the **Select** soft key.
4. Change the number as required. Press the **Save** soft key. If no change is required press the **Exit** soft key.

| To...            | Then press the...  |
|------------------|--|
| call the number  |  key.   |
| store the number | <b>Save</b> soft key and enter the name and location required (for further details, refer to “Storing a Number with a Name” on page 41). |

## Deleting a Missed Call



1. Press the **Options** soft key.
2. If necessary, press the  or  key to highlight the **Delete** option.
3. Press the **Select** soft key to go to the Options menu.

You can press the  key at any time to exit the Missed Call feature.

**Note:** You can access the Missed Call feature at any time by selecting the Missed Calls menu option (**Menu 3.1**); for further details, see “Missed Calls” on page 91.



## Switching Quickly to the Silent Mode

The Silent Mode is convenient when discretion is required and you wish to stop the phone from making any noise, in a theater for example.

In idle mode, to switch your phone quickly to the silent mode, simply press and hold down the  key until the “Silent Mode” message and vibration icon  are displayed.



In the silent mode, your phone changes the sound settings as follows.

| Option                           | New Setting |
|----------------------------------|-------------|
| Alert Type ( <b>Menu 5.4</b> )   | Vibration   |
| Keypad Tone ( <b>Menu 5.5</b> )  | Off         |
| Folder Tone ( <b>Menu 5.7</b> )  | Off         |
| Power On/Off ( <b>Menu 5.8</b> ) | Off         |
| Extra Tones ( <b>Menu 5.9</b> )  | Off         |

To exit the silent mode and reactivate the previous Sound Settings, press and hold the  key again until “Exit Silent Mode” appears. The vibration icon () is no longer displayed.



# Selecting Functions and Options

Your phone offers a set of functions that allow you to customize your phone. These functions are arranged in menus and sub-menus, accessed via the two soft keys marked  and . Each menu and sub-menu allows you to view and alter the settings of a particular function.

The roles of the soft keys vary according to the current context; the label on the bottom line of the display just above each key indicates its current role.



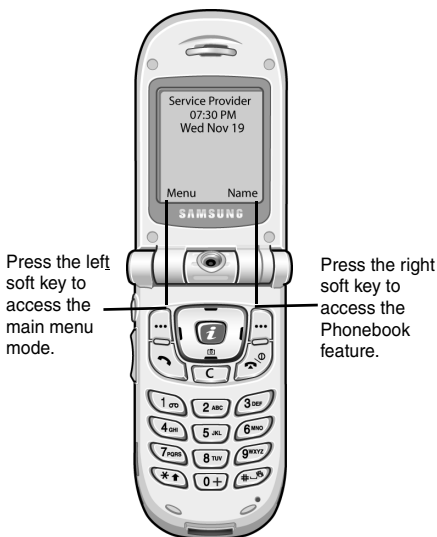





Example:







To view the various functions/options available and select the one required, proceed as follows.

1. Press the appropriate soft key.







| To...  | Then press the...   |
|--|---|
| select the: <ul style="list-style-type: none"><li>• Function displayed</li><li>or</li><li>• Option highlighted</li></ul> | Select soft key or the  key.   |
| view the next function or highlight the next option in a list  |  key or  key on the left side of the phone.   |
| move back to the previous function or option in a list   |  key or  key on the left side of the phone.   |
| move back up one level in the structure  |  key,  soft key or  key. |
| exit the structure without changing the settings   |  key.  |



In some functions, you may be asked for a password or PIN. Enter the required code and press the **OK** soft key.

## Example: Setting the Display Language

1. When the idle screen is displayed, press the **Menu** soft key to access the menus.
2. Scroll through the menus until you reach the Phone Settings menu, by pressing the  or  key.
3. To select the Phone Settings menu, press the **Select** soft key or the  key.

**Note:** If the menu name is too long for the display, it will scroll when highlighted.

4. Scroll through the sub-menus until you reach the Language sub-menu, by pressing the  or  key.
5. To view the languages available, press the **Select** soft key or the  key. The current setting is highlighted.
6. Scroll through the list of languages until the appropriate one is highlighted, by pressing the  or  key.
7. Press the **Select** soft key or the  key to confirm your selection.

Press the  or  key twice to exit the menu structure.



# Phonebook

You can store phone numbers and their corresponding names in the memory of your SIM card. In addition, you can store up to 500 numbers in the phone memory. The SIM card and phone memories, although physically separate, are used as if they were a single entity, called the Phonebook.

## Storing a Number with a Name

There are two ways to store a number:

1. Using the **Save** soft key in idle mode
2. Using the New Entry option in the Phonebook menu

## Storing a Number in Idle mode



As soon as you start to enter a number, **Save** appears above the left soft key to allow you to store the number in the phonebook.

1. Key in the number to be stored.

**Note:** If you make a mistake while entering a number, correct it using the  key. For further details, refer to “Correcting the Number” on page 30.

2. When you are sure that it is correct, press the **Save** soft key.
3. Select an entry type to identify the category of number to be stored. Three categories are available:
  - Mobile Number
  - Work Number

## ● Home Number

4. To select the category, press the  or  key, followed by the **Select** soft key.
5. Enter a name and press the **OK** soft key.

The maximum length of a name depends on your SIM card. For information on how to enter characters, see “Entering Text” on page 51.

The phone now displays the first free location in the last memory used to save a number and name. If that memory is full, the first free location in the other memory is displayed.



6. Press the right soft key, labeled **To Card** or **To Phone** to toggle between the phone and card memories.

**Note:** If you change phones, any numbers stored in your SIM card memory will automatically be available with the new phone, whereas any numbers stored in the phone memory must be restored.

7. If you do not want to save the number and name in the suggested location, press the  key to clear the location number and enter your preferred location by pressing the number keys.
8. Press the **OK** soft key to store the name and number.
9. After storing, the phone displays the phonebook entry or name just created.

| To...                     | Then press the...  |
|---------------------------|--|
| Use the entry options     | <b>Options</b> soft key.   |
| Return to the idle screen |  key. |



## Storing a Number Using the Phonebook Menu

1. When the idle screen is displayed, press the **Name** soft key.
2. Scroll to **New Entry** by pressing the  or  key and press the **Select** soft key.
3. Select an **Entry Type** to identify the category of the number to be stored. The following four options are provided:
  - Mobile Number
  - Work Number
  - Home Number
  - E-mail Address
4. Continue the procedure from Step 4 on “Enter a name and press the OK soft key.” on page 42 to store the number.



**Note:** The E-mail icon is available in this step. It allows you to save an E-mail address instead of a phone number.

## Using Phonebook Entry Options

While accessing any phonebook entry, press the **Options** soft key to access the options for the entry.

| To...                         | Then press the...  |
|-------------------------------|--|
| Select the highlighted option | <b>Select</b> soft key or the  key.   |
| Highlight a different option  |  or  key until the required option is highlighted. |

The following options are available.

- **Paste:** allows you to paste the selected number into the normal dialing mode. Use this option to dial a number similar to one in the phonebook, a different extension in the same office, for example. Use the  key to change the number as required; refer to “Correcting the Number” on page 30 for further details. When you are ready to dial, press the  key.
- **Edit:** allows you to edit the phonebook entry. Select **One Entry** to change one number in the selected name. If you change the name, the number is saved separately. Select **All Entry** to change the name of the entry.
- **Erase:** allows you to erase the selected name and number from the phonebook. You are asked to

confirm that you wish to erase the name and number by pressing the **Yes** soft key.

- **Copy:** allows you to copy the selected number to another location. Use this option to store a number similar to one already in memory; once copied, edit the number and store it in the Phonebook.
- **Caller Group:** allows you to assign the entry to a caller group so that the phone alerts you in a particular way when the corresponding person calls you. Select one of the ten groups available. To remove an entry from a group, select the No Group option. For more information on how to change caller group properties, see “Editing a Caller Group” on page 47.
- **Add Entry:** allows you to add a new number in a different category (mobile, office, home or E-mail) to the currently selected name. A phonebook entry or name can contain up to four numbers, one in each category.

## Searching for a Number in the Phonebook

After storing numbers in the phonebook, you can search for them in two ways: by name and by caller group.

### Searching for a Number by Name



1. When the idle screen is displayed, press the **Name** soft key.
2. Press the **Select** soft key when **Search** is highlighted. You are asked to enter a name.



3. Enter the first few letters of the name that you wish to find.



The phonebook entries are listed, starting with the first entry matching your input. This entry is also highlighted.

4.

| To...  | Then press the...   |
|--|---|
| View the highlighted entry                       | <b>View</b> soft key.   |
| Select a different entry                         |  or  key until the required entry is highlighted. |
| Look for a name starting with a different letter | To clear previously entered text, press the  key.  |

5. Once you have found the required entry, press the  key to dial the number, or press the **Options** soft key to access the phonebook entry options; for further details, see “Using Phonebook Entry Options” on page 44.

## Searching for a Number by Caller Group

1. When the idle screen is displayed, select the **Name** soft key. Scroll to Group Search by pressing the  or  key and press the **Select** soft key. You are asked to enter a group name.
2. Enter the first few letters of the group name that you wish to find.

The caller groups are listed, starting with the first group matching your input. The group is also highlighted.

3. Scroll to the required group by pressing the **▲** or **▼** key and press the **View** soft key.

The phonebook entries in the selected caller group are listed.



4.

| To...                      | Then press the...   |
|----------------------------|---|
| View the highlighted entry | <b>View</b> soft key.   |
| Select a different entry   | <b>▲</b> or <b>▼</b> key until the required entry is highlighted. |

5. Once you have found the required entry, press the **■** key to dial the number, or press the **Options** soft key to access the phonebook entry options; for further details, see “Using Phonebook Entry Options” on page 44.

## Editing a Caller Group

1. When the idle screen is displayed, select the **Name** soft key.
2. Scroll to **Group Edit** by pressing the **▲** or **▼** key and press the **Select** soft key.
3. Enter the start of the required group name or scroll through the group list by pressing the **▲** or **▼** key.





4. When the required group is highlighted, press the **Options** soft key.
5. Select each option and change the settings, as required. The following options are available.
  - **Call ring tone:** allows you to select the ring tone to be used when you receive a voice call from a person in the group.
  - **SMS tone:** allows you to select the ring tone to be used when you receive a text message from a person in the group.
  - **Graphic:** allows you to select the graphic icon to be displayed when you receive a voice call from a person in the group.
  - **Group Name:** allows you to assign a name to the group; for further details on how to enter characters, see “Entering Text” on page 51.
6. When you have finished, press the  or  key.

## Speed-Dialing



Once you have stored phone numbers in the SIM card, you can set up to eight speed-dial entries and then dial them easily whenever you want, simply by pressing the associated number key.



## Setting Up Speed-Dial Entries

1. When the idle screen is displayed, select the **Name** soft key.



2. Scroll to **Speed Dial** by pressing the  or  key and press the **OK** soft key.
3. Select the key to which you wish to assign the speed-dialing feature (keys  to ) and press the **OK** soft key.

**Note:** If you have already assigned a number to the key, the Options soft key replaces the OK soft key. Go to Step 6.

4. Select the required Phonebook entry from the list and press the **View** soft key.
5. Select the required number if the entry has more than one number, by pressing the  or  key and press the **Select** soft key.
6. Once you have assigned a number to the selected key, four options are available:
  - **Change:** allows you to assign a different number to the key.
  - **Erase:** allows you to clear the setting so that no number is assigned to the key.
  - **Erase All:** allows you to clear the settings for all keys so that no numbers are assigned to any of the keys.
  - **Number:** allows you to view the number assigned to the key.

7. When you have finished, press the  or  key.



## Speed-Dialing from the Phonebook

To speed-dial the numbers assigned to keys  to , press and hold down the appropriate key.

**Note:** Memory location 1 is reserved for your Voice Mail server number and cannot be changed.

## Checking Memory Status

You can check how many names and numbers are stored in the phonebook (card and phone memories) or how many free locations remain.

1. When the idle screen is displayed, select the **Name** soft key.
2. Scroll to Memory Status option pressing the **6** or  key and press the **Select** soft key.
3. Press the  or  keys to view the number of existing and remaining entries in the card and phone memories.

# Entering Text

When using your phone, you will often need to enter text. For example, when storing a name in the phonebook, creating your personal greeting or scheduling events in your calendar. You can enter alphanumeric characters by using your phone's keypad.

You are provided with the following text input modes.

- **T9 mode:** This mode allows you to enter words with only one keystroke per letter. Each key on the keypad has more than one letter – when you press the  key once, J, K or L may be displayed. The T9 mode automatically compares your keystrokes with an internal linguistic dictionary to determine the correct word, thus requiring far fewer keystrokes than the traditional upper/lower-case character modes.
- **Upper/lower-case character modes:** These modes allow you to enter letters by pressing the key labeled with the required letter once, twice, three or four times until the letter is displayed.
- **Number mode:** This mode allows you to enter numbers.
- **Symbol mode:** This mode allows you to enter symbols, such as punctuation marks.

## Changing the Text Input Mode

When you are in a field that allows characters to be entered, you will notice the text input mode indicator in the display.

To select the...

Then press the  soft key  
until...

T9 mode

 displays.

Upper-case  
character mode

 displays

Lower-case  
character mode

 displays

Symbol mode



 displays.

Number mode

 displays

## Using the T9 Mode



The T9 predictive text input mode allows you to key in any character using single keystrokes. This text input mode is based on a built-in dictionary.



1. When you are in the T9 predictive text input mode, start entering a word by pressing keys  to  .  
Press each key only once for one letter.

Example: to enter HELLO in the T9 mode,  
press , , ,  and  .



The word that you are typing appears in the display. It may change with each key that you press.



2. Enter the whole word before editing or deleting the keystrokes.

3. If the word is correct, start entering the next word.
4. Otherwise, press the ,  or  key repeatedly to display alternate word choices for the keys that you have pressed.

Example: both OF and ME have the sequence  and . The phone displays the most commonly used choice first.

5. Complete each word with a space by pressing the  key.

- To type words not found in the T9 mode, change the text input mode to the upper/lower-case character input mode.
- To enter full stops, hyphens or apostrophes, press the  key. The T9 mode applies grammar rules to ensure that the correct punctuation is used.
- To change the case in the T9 mode, use the \* key.
- You can move the cursor by using the  and  keys.

To delete letters, press the  key. Press and hold down the  key to clear the display.

## Using the Upper/Lower-Case Character Mode

Use the  to  keys to enter your text.

1. Press the key labeled with the required letter:
  - Once for the first letter
  - Twice for the second letter, and so on







## 2. Select the other letters in the same way.

**Note:** The cursor moves to the right when you press a different key. When entering the same letter twice or a different letter on the same key, just wait for a few seconds for the cursor to move right automatically, and then select the next letter.

Refer to the table below for more information about the characters available.

| Key | Characters in the Order Displayed |                    |
|-----|-----------------------------------|--------------------|
|     | Upper Case                        | Lower Case         |
| 1   | . 1 ! ? & i ¿ §                   | . % @ _ £ \$ ¥ ¤ § |
| 2   | A B C 2 Ä Å Æ Ç Γ                 | a b c 2 à ä å æ Γ  |
| 3   | D E F 3 É Δ Φ                     | d e f 3 è é Φ      |
| 4   | G H I 4 Θ Ψ                       | g h i 4 ì Ψ        |
| 5   | J K L 5 Λ                         | j k l 5 λ          |
| 6   | M N O 6 Ñ Ø Ö ö                   | m n o 6 ñ ø ò ö    |
| 7   | P Q R S 7 Π Σ Ξ                   | p q r s 7 β Σ Ξ    |
| 8   | T U V 8 Ü ü                       | t u v 8 ù ü        |
| 9   | W X Y Z 9 Ω                       | w x y z 9 Ω        |
| 0   | 0 * # , ; ' " =                   | / : - + ( ) < >    |
| #   | Space                             |                    |

- To insert a space, press the  key.
- You can move the cursor by using the  and  keys.  
To delete letters, press the  key. Press and hold down the  key to clear the display.

## Using the Symbol Mode

The Symbol mode enables you to insert symbols in a text message.

Use the navigation keys to scroll to the desired symbol and then press **OK** soft key to insert the highlighted symbol into your message.

## Using the Number Mode

The Number mode enables you to enter numbers in a text message (a telephone number for example). Press the keys corresponding to the required digits before manually switching back to the appropriate text input mode.



# Options During a Call

Your phone provides a number of control functions that you can use during a call.

## Putting a Call on Hold

You can place the current call on hold at any time. You can make another call while you have a call in progress if this service is supported by the network. Of these two calls, one is active and the other is on hold and you can switch between the calls.

To place a call on hold, simply press the **Hold** soft key. You can reactivate the call whenever you want, by pressing the **Unhold** soft key.

To make a call while you have a call in progress, proceed as follows.

1. Key in the phone number that you wish to dial or look it up in the phonebook.
2. Press the  key to dial the second call.
3. The first call is automatically put on hold.

Or alternatively, proceed as follows.

1. Put the current call on hold by pressing the **Hold** soft key.
2. Make the second call in the normal way.

To swap between the two calls, simply press the **Swap** soft key.

The current call is placed on hold and the call on hold is reactivated so that you can continue conversing with the other party.

When you have finished, end each call normally by pressing the  key.

## Switching the Microphone Off (Mute)

You can temporarily switch your phone's microphone off, so that the other party cannot hear you.

**Example:** You wish to say something to another person in the room but do not want the other party to hear you.

To switch the microphone off temporarily, use the following steps:

1. Press the **Options** soft key.
2. If necessary, press the  key to highlight the **Mute** option.
3. Press the **OK** soft key.

The other party can no longer hear you.

To switch the microphone back on, proceed as follows.

1. Press the **Options** soft key.
2. If necessary, press the  key to highlight the **Unmute** option.
3. Press the **OK** soft key.

The other party can hear you again.

## Muting/Sending DTMF

These options allow you to turn the key tones off or on. If the **Mute keys** option is selected, your phone does not transmit the key tones. It allows you to press keys without hearing any key tones during a call.

**Note:** To communicate with answering machines or computerized telephony systems, the **Send keys** option must be selected.

## Sending DTMF Tones

You can send the DTMF (dual tone multi-frequency) tones corresponding to a number entered during a call.

This option is helpful when submitting a password or account number to an automated system, like a banking service.

To send DTMF tones, use the following steps:

1. When you are connected to the teleservice system, press the **Options** soft key.
2. Press the  key to highlight the **Send DTMF** option.
3. Press the **OK** soft key.
4. Enter the number you wish to send and press the **OK** soft key. The tones corresponding to the number displayed are sent.

**Note:** You can also search for a number in the phonebook by pressing the **Name** soft key. For a ore detailed description of the Phonebook feature, refer to “Storing a Number with a Name” on page 41.

## Searching for a Number in the Phonebook

You can search for a number in the phonebook during a call.

1. Press the **Options** soft key.
2. Press the **■** key to highlight the **Phonebook** option.
3. Press the **OK** soft key.

The phonebook entries are listed.

4. Enter the name that you wish to find.

If you enter the start of the name, the phonebook entries are listed, starting with the first entry matching your input. The entry is also highlighted.

5. To view the highlighted entry, press the **View** soft key.

For a more detailed description of the Phonebook feature, refer to “Phonebook” on page 41.

## Using the SMS Service

If you receive an SMS (Short Message Service) message during a call, the message icon (  ) flashes on the display. The **SMS Services** option enables you to use this feature.

For further details on the SMS service, refer to “Text Messages” on page 73.

## Answering a Second Call

You can answer an incoming call while you have a call in progress, if this service is supported by the network and you have set the **Call Waiting** menu option to **Activate** (see “Call Waiting” on page 124). You will be notified of an incoming call by a call waiting tone.

To answer a call while you have a call in progress, proceed as follows:

1. Press the  key to answer the incoming call. The first call is automatically put on hold.
2. To switch between the two calls, press the **Swap** soft key.

To end a held call, press the **Options** soft key and select the **End Held Call** option.

3. To end the current call, press the  key.

## Making a Multiparty Call

A multiparty call is a network service that allows up to six people to take part simultaneously in a multiparty or conference call. For more information, contact your service provider.

## Setting up the Multiparty Call

1. Call the first participant in the normal way.
2. Call the second participant in the normal way. The first call is automatically put on hold.
3. To join the first participant to the multiparty call, press the **Options** soft key and select the **Join** option.
4. To add a new person to the multiparty call, call the person in the normal way, then press the **Options** soft key and select the **Join** option.



You can add incoming callers by answering the call and pressing **Options**, followed by **Join**. Repeat as required.



## Having a Private Conversation With One Participant

1. Press the **Options** soft key and choose the **Select one** option.

The list of call participants appears.

2. Highlight the required person, by pressing the  or  key, followed by the **Select** soft key or the  key.

3. Select the **Private** option.

Now you can talk privately with that person. The other participants can continue to converse with each other.



4. To return to the multiparty call, press the **Options** soft key and select **Conference**.

All the multiparty call participants can now hear each other.

## Dropping One Participant

1. Press the **Options** soft key and choose the **Select one** option.

The list of call participants appears.

2. Highlight the required person, by pressing the  or  key, followed by the **Select** soft key or the  key.

3. Select **Remove**.

The call is ended with that participant, but you can continue to talk with the other participants.

4. End the multiparty call by closing the phone or pressing the  key.







# Using the Menus





The phone offers a range of functions that allow you to tailor the phone to your needs. These functions are arranged in menus and sub-menus.

The menus and sub-menus can be accessed by scrolling with the navigation keys or by using the shortcuts.

## Accessing Menu Functions by Scrolling

1. In idle mode, press the **Menu** soft key to access the menu facility.
2. Scroll with the  or  key to reach the required main menu, **Phone Settings** for example. Press the **Select** soft key or the  key to enter the menu.
3. If the menu contains any sub-menus, **Language** for example, you can access them by scrolling with the  or  key and pressing the **Select** soft key.

If the menu that you have selected contains further options, repeat the same procedure.

| To...                      | Then press the...   |
|----------------------------|---|
| Scroll through the menus   |  or  key or use the  and  keys on the left side of the phone. |
| Confirm the chosen setting | <b>Select</b> soft key or the  key.  |

| To...                                       | Then press the...   |
|---|---|
| Return to the previous menu level           |  soft key. |
| Exit the menu without changing the settings |  key.      |

## Accessing Menu Functions by Using Shortcuts

The menu items (menu, sub-menus and options) are numbered and can be accessed quickly by using their shortcut number. The shortcut number is shown in the bottom right next to the  soft key on the display. Simply press the **Menu** soft key and key in the required number.

**Example:** Accessing the **Language** option.

1. Press the **Menu** soft key.
2. Press  for **Phone Settings**.
3. Press  for **Language**.

The languages available are displayed directly.

**Note:** The numbers assigned to each menu option are indicated in the list on the following page. They may not match the menu number on the phone. It depends on the services supported by the SIM card.

## List of Menu Functions

The following illustration shows the menu structure available and indicates the:

- Number assigned to each option
- Page on which you can find a description of each feature

**Note:** If you use a SIM AT card that provides additional services, the **SIM AT** menu (x) is displayed first when you press the **Menu** soft key to enter the menu facility. For further details, refer to your SIM card documentation.

## 1. Text Messages

- 1.1 Inbox
- 1.2 Outbox
- 1.3 Write New
- 1.4 Templates
- 1.5 Settings
  - 1.5.1 Setting 1 \*
  - 1.5.2 Setting 2 \*
  - 1.5.3 Common Setting
- 1.6 My Objects
  - 1.6.1 My EMS Melody
  - 1.6.2 My EMS Picture
  - 1.6.3 My EMS Animation
  - 1.6.4 Delete All
- 1.7 Delete All
- 1.8 Memory Status
  - 1.8.1 SIM memory
  - 1.8.2 PHONE memory
  - 1.8.3 CB memory \*
- 1.9 Voice Mail
  - 1.9.1 Connect to Voice Mail
  - 1.9.2 Voice Mail Number
- 1.0 Broadcast \*

## 2. Multimedia Messages

- 2.1 Inbox
- 2.2 Outbox
- 2.3 Shop MMS
- 2.4 Write New
- 2.5 Delete All
- 2.6 Setup
- 2.7 MMS Profile

## 3. Call Records

- 3.1 Missed Calls
- 3.2 Incoming Calls
- 3.3 Outgoing Calls
- 3.4 Delete All
- 3.5 Call Time
  - 3.5.1 Last Call Time
  - 3.5.2 Total Outgoing
  - 3.5.3 Total Incoming
  - 3.5.4 Reset Timers

## 4. Camera

- 4.1 Take and Send
- 4.2 New Photo
- 4.3 My Photos

## 5. Sound Settings

- 5.1 Ring Tone
- 5.2 Ring Volume
- 5.3 Shop Ringtones
- 5.4 Alert Type
  - 5.4.1 Light only
  - 5.4.2 Melody
  - 5.4.3 Vibration
  - 5.4.4 Vibra+Melody
- 5.5 Keypad Tone
  - 5.5.1 OFF
  - 5.5.2 Cool
  - 5.5.3 Piano
  - 5.5.4 Tone
  - 5.5.5 Beep
- 5.6 Message Tone
  - 5.6.1 SMS Tone
  - 5.6.2 SMS-CB Tone
- 5.7 Folder Tone
  - 5.7.1 Off
  - 5.7.2 Future
  - 5.7.3 Crystal

- 5.8 Power On/Off
  - 5.8.1 Off
  - 5.8.2 Classical
  - 5.8.3 Cheerful
- 5.9 Extra Tones
  - 5.9.1 Error Tone
  - 5.9.2 Minute Minder
  - 5.9.3 Connect Tone

## 6. Phone Settings

- 6.1 Infrared Activate
- 6.2 My Settings
  - 6.2.1 Wallpaper
  - 6.2.2 Menu Style
    - 6.2.2.1 Film Style
    - 6.2.2.2 Page Style
  - 6.2.3 Shop Graphics
- 6.3 Greeting Message
- 6.4 Own Number
- 6.5 Language
  - 6.5.1 English
  - 6.5.2 Spanish
  - 6.5.3 French
  - 6.5.4 Automatic
- 6.6 Security
  - 6.6.1 PIN Check
  - 6.6.2 Change PIN
  - 6.6.3 Phone Lock
  - 6.6.4 Change Password
  - 6.6.5 SIM Lock
  - 6.6.6 FDN Mode \*
  - 6.6.7 Change PIN2
- 6.7 Display Settings
  - 6.7.1 Brightness
  - 6.7.2 Back Light
  - 6.7.3 Auto Light

---

\*. Shown only if supported by your SIM card.



- 6.7.4 Service Light
- 6.7.5 Graphic Logo
- 6.8 Extra Settings
  - 6.8.1 Auto Redial
  - 6.8.2 Active Folder
  - 6.8.3 Anykey Answer
- 6.9 Short Cut
  - 6.9.1 Key Up
  - 6.9.2 Key Right
  - 6.9.3 Key Left
- 6.10 TTY Setting
  - 6.10.1 Enable
  - 6.10.2 Disable
- 6.11 Reset Settings

## 7. Organizer

- 7.1 Calendar
- 7.2 To Do List
- 7.3 Time & Date
  - 7.3.1 Set Time
  - 7.3.2 Set Date
  - 7.3.3 World Time
  - 7.3.4 Time Format
- 7.4 Alarm
  - 7.4.1 Once Alarm
  - 7.4.2 Daily Alarm
  - 7.4.3 Morning Call
  - 7.4.4 Remove Alarm
  - 7.4.5 Autopower
- 7.5 Calculator
- 7.6 Currency Exchange

## 8. Network Services

- 8.1 Call Forwarding
  - 8.1.1 Forward Always
  - 8.1.2 Busy
  - 8.1.3 No Reply

- 8.1.4 Unreachable
- 8.1.5 Cancel All
- 8.2 Call Barring\*
  - 8.2.1 All Outgoing
  - 8.2.2 International
  - 8.2.3 International Except to Home
  - 8.2.4 All Incoming
  - 8.2.5 Incoming While Abroad
  - 8.2.6 Cancel All
  - 8.2.7 Change Barring Password
- 8.3 Call Waiting
- 8.4 Network Selection\*
  - 8.4.1 Automatic
  - 8.4.2 Manual
- 8.5 Caller ID
  - 8.5.1 Default
  - 8.5.2 Hide Number
  - 8.5.3 Send Number
- 8.6 Closed User Group\*
  - 8.6.1 Index List
  - 8.6.2 Outside Access
  - 8.6.3 Default Group

## 9. Funbox

- 9.1 Games
- 9.2 WAP Browser
  - 9.2.1 Home
  - 9.2.2 Favorites
  - 9.2.3 http://
  - 9.2.4 Settings
  - 9.2.5 Clear Cache
  - 9.2.6 Push Message
- 9.3 Downloads
  - 9.3.1 Sounds
  - 9.3.2 Pictures



# Text Messages

The SMS (Short Message Service) function is a network service and may not be supported by your network.



Messages can be sent by text, fax, Email and paging messaging systems, provided that these services are supported by your network. To send text messages by phone, you must obtain the number of the SMS center from your service provider.

When the message icon () appears, you have received new text messages. If the message memory is full, an error message is displayed and you cannot receive any new messages. Use the **Delete** option in each message box to delete obsolete ones.

## Inbox

This message box is used to store the messages that you have received.

When you enter this menu, the list of messages in the box displays with the senders' phone numbers or names, if available in your Phonebook.

1. Select a message from the list and press the **View** soft key to read the message contents.
2. To scroll through the contents, press the .
3. To scroll to the previous or next messages, press the  or  key.

While reading a message, you can choose the following options by pressing the **Options** soft key.

**Delete:** allows you to delete obsolete messages.

**Send:** allows you to resend the message.

**Reply:** (inbox only): allows you to reply to the sender by sending a text message. You can also change the SMS center number, if required.

**Call Back:** (inbox only): allows you to call the sender back.

**Cut Address:** allows you to extract a number from the message text, so that you can call the number or save it in the phonebook.





**Move:** allows you to move the message to the phone or SIM memory.

**Select Objects:** allows you to save the objects, such as sounds or images, from the message into your phone. You can then use the objects when writing a message; for details, see “Creating a Message using the Options” on page 76.

## Outbox

This message box is used to store the messages that you have already sent or will send.

When you enter this menu, the list of messages in the box displays with the recipients phone numbers or names, if available in your Phonebook.

1. Select a message from the list and press the **View** soft key to read the message contents.
2. To scroll through the contents, press the  or .
3. To scroll to the previous or next messages, press the  or  key.

While Reading a message, you can choose the following options by pressing the **Options** soft key.

**Delete:** allows you to delete messages.

**Send:** allows you to resend the message.

**Save Address:** allows you to extract a number from the message text, so that you can call the number or save it in the phonebook.

**Move:** allows you to move the message to the phone or SIM memory.

**Select Objects:** allows you to save the objects, such as sounds or images, from the message into your phone. You can then use the objects when writing a message.

## Write New

In this menu, you can write and send a text message.

**Note:** You can enter up to 918 alphanumeric characters for your message. If you add objects to the message, the number of characters you can enter will be decreased.

## Creating a Simple Text Message

1. Create your message as required.

**Note:** For more information about entering characters, refer to “Entering Text” on page 51.

2. When you have completed your message, press the **Options** soft key. The following options are available.

- **Send:** allows you to send the message. The message will be deleted after sending.
- **Save and Send:** allows you to save a copy of the message into the specified memory and then send

the message to the destination. You can read the message in your Outbox.

- **Save:** allows you to save the message into the specified memory so that it can be sent later. You can read the message in your Outbox.
- For information about the **Text Formatting, Add Objects, Add Templates, Add Phonebook, Add Bookmark** and **Language** options, see “Creating a Message using the Options” on page 76.

3. Select **Send** or **Save and Send**, and press the **Select** soft key.

If you want just to save the message, select **Save**. After saving the message, the phone returns to the **Messages** menu.

4. Select the memory where the message is saved and press the **OK** soft key.
5. Enter a destination number and press the **OK** soft key. The message is sent.

## Creating a Message using the Options

1. Create your message.
2. Press the **Options** soft key.
3. Select one of the following options as required by using the **Up** and **Down** keys and pressing the **Select** soft key.

**Text Formatting:** allows you to format the style of the text. For the **Size** attribute, the **Normal, Large** and **Small** sizes

are available. For the Underline and **Strike through** attributes, select **On** or **Off**. The attributes can be combined.

**Add Objects:** allows you to add the required sound, melody picture or animation to the message. Select the category of the object to be added: **Sound**, **Melody**, **Picture** and **Animation** are available. In each category, you can select the various factory-set items or choose an item received from other sources, such as the Internet or other phones.

**Add Templates:** allows you to apply one of the preset message templates to the text. Select one of the nine messages predefined via the **Templates** menu option (Menu 1.4).



**Add Phonebook:** allows you to search through your entries in your phonebook.

**Add Bookmark:** allows you to select from bookmarks you've previously entered into your phone.

**Language:** allows you to change the language to be used in the T9 input mode. Select the language to be used.

4. Complete the message, and send or save it by following the procedure from Step 2 on page 75.

## Templates

Using this menu, you can preset up to nine messages that you use most frequently. Scroll through the template list using the  and  keys. When the required message template is highlighted, press the **Select** soft key.

**Edit:** allows you to write a new message or edit the selected message.



**Note:** For further information on how to enter characters, refer to “Entering Text” on page 51.

**Send Message:** allows you to recall the selected message. Once you have completed the message, you can send, save and send, or simply save it. For details on how to send a message, see page 75.

**Delete:** allows you to delete the selected message. You are asked to confirm the deletion by pressing the **Yes** soft key.

## Settings

In this menu, you can set up default SMS information. A setting group is a collection of settings required to send messages. The number of setting groups available depends on the capacity of your SIM card.

**Setting x** (where **x** is the setting group number): each group has its own sub-menu.

**SMS Center:** allows you to store or change the number of your SMS center required when sending messages. You must obtain this number from your service provider.

**Destination:** allows you to store the default destination number. The number will automatically display on the Destination screen when you create a message.

**Default Type:** allows you to set the default message type (Text, Fax, Email and Paging). The network can convert the messages into the selected format.

**Default Validity:** allows you to set the length of time for which your text messages will be stored at the message center while attempts are made to deliver them.

**Setting Name:** allows you to give a name to the setting group currently being defined.

**Common Setting:** four options are available.

Reply Path: allows the recipient of your SMS message to send you a reply message via your message center, if the service is provided by the network.

Delivery Reports: allows you to activate or deactivate the report function. When this function is activated, the network informs you whether your message has been delivered or not.

Bearer Selection: allows you to choose between **GSM** and **GPRS**.

## My Objects

After saving any objects received from messages into your phone memory, using the **Select Objects** option, you can see the items in this menu.

Four categories of items are available:

- My EMS Melody
- My EMS Picture
- My EMS Animation
- Delete All

You can forward the items to other people by messages and/or use them for your ring tone or background image. You can delete all of the items using the **Delete All** option.

| To...                          | Press the key           |
|--------------------------------|-------------------------|
| select a message box to delete | <b>Mark</b> soft key    |
| cancel the selection           | <b>Unmark</b> soft key. |

| To...  | Press the key           |
|--|-------------------------|
| delete the items in the selected message box | <b>Delete</b> soft key. |

If you want to delete all of the media items, select **All Object**.

## Delete All

You can delete all of the messages in each message box using the **Delete all** option.

| To...  | Press the key           |
|--|-------------------------|
| select a message box to delete               | <b>Mark</b> soft key    |
| cancel the selection                         | <b>Unmark</b> soft key. |
| delete the items in the selected message box | <b>Delete</b> soft key. |

If you want to delete all of the media items, select **All Messages**.

## Memory Status

This menu shows how many messages are currently stored in the SIM, PHONE and CB memories.

## Voice Mail



This menu provides you with a way of accessing your voice mailbox (if provided by your network).

The following options are available.

**Connect to Voice Mail:** before using this feature, you must enter the voice server number obtained from your service provider (see menu option 1.9.1). You can then select this option and simply press the **OK** soft key to listen to your messages.

To quickly connect to the voice server, press and hold down the  key in idle mode.

**Voice Mail Number:** allows you to change the voice mail server number, if necessary.

| To...  | Then press the...   |
|--|---|
| Enter the server number                                      | Corresponding numeric keys.   |
| Correct a digit  |  key.  |
| Move the cursor to the left/right without clearing the digit |  or  key. |

**Note:** Voice Mail is a network feature. Please contact your service provider for more information.

## Broadcast

This network service allows you to receive text messages on various topics, such as the weather or traffic.

Messages are displayed immediately they are received, provided that:

- The phone is in idle mode
- The **Receive** option is set to **Enable**
- The message channel is currently active in the channel list

The following options are available.

**Read:** lets you view the message. **Volatile** displays the messages from the network, but loses its contents as soon as the phone is switched off. Scroll through the message by using the **Left** and **Right** keys. While reading a message, press the **Save** soft key to store the message in the **Archive** box for later retrieval.

**Receive:** allows you to enable or disable the reception of broadcast messages.

**Channel List:** allows you to indicate the channels from which you wish to receive broadcast messages. The following options are available.

Select: used to enable or disable channels in the list by marking or un-marking them respectively (a check mark is displayed in front of each channel selected).

Add Channel: used to declare the ID and title for a new channel.

Delete: used to remove a channel from the list.

Edit: used to change the ID and title of an existing channel.

**Language:** allows you to select your preferred language to be used when displaying cell broadcast messages.

Please contact your service provider for more information.

# Multimedia Messages

Multimedia Message Service (MMS) is a messaging service very similar to Short Message Service (SMS). It provides automatic and immediate delivery of personal multimedia messages from phone to phone or from phone to e-mail. In addition to the familiar text content of text messages, multimedia messages can contain images and graphics. An MMS message is a multimedia presentation in a single entry. It is not a text file with attachments. Using the MMS feature, your phone can receive multimedia messages. You can also send picture messages, which are short messages that contain images, such as your photos or graphics you downloaded from the Internet. This function is available only if it is supported by your service provider. Only phones that offer picture message features can receive and display picture messages.



## Inbox

### Viewing a Message When You Receive it

When a new multimedia message comes in, the display shows the text notification along with the sender's number.

1. Press the **View** soft key to view the message.

The display shows brief information about the message, such as the sender's number, the message size and the subject. If you want to view the message later in the Inbox, press the **Exit** soft key.

2. To scroll through the message information, press the  or  key.

While viewing the information, press the **Options** soft key to use the following options:

If you are viewing a new message, the options are the same as when you view a message as soon as you receive it.

When you are reviewing message, the following options are available:

**Delete:** deletes the message.

**Reply:** allows you to reply to the sender by sending a text or picture message.

**Call Back:** all you to reply to the sender by sending a text or picture message.

**Cut Address:** allows you to extract a number from the message text, so that you can call the number or save it in the Phonebook.

**Forward:** allows you to forward the message to another person.



**Save Picture:** allows you to save an image from the message into your phone. Photos are stored in the **My Photos** folder and other images are in the **Pictures** folder in the **Downloads** menu.

**Save Sound:** allows you to save a sound from the message into the **Sounds** folder in the **Downloads** menu.

## Viewing a Received Message in the Inbox

When you access the **Inbox** menu option, the list of multimedia messages you received displays with the

senders' phone numbers, if they are available in your Phonebook, or subjects.

1. Select a message and press the **Select** soft key to view the message.
2. To scroll through the message, press the  or  key.

While viewing a message, you can choose the Message options by pressing the **Options** soft key.

If you are viewing a new message, the options are the same as when you view a message as soon as you receive it. See the previous section.

When you are reviewing a message, the following options are available:

**Delete:** deletes the message.

**Reply:** allows you to reply to the sender by sending a text or picture message.

**Callback:** allows you to call the sender back.

**Cut Address:** allows you to extract the origination number from the message, so that you can call the number or save it in your Phonebook.

**Forward:** allows you to forward the message to another person.

**Save Picture:** allows you to save an image from the message into your phone. Images are stored in the **Pictures** folder in the **Fun Box** menu option.

**Save Sound:** allows you to save a sound from the message into the **Sounds** folder in the **Fun Box** menu option.



## Outbox

When you access this menu option, the list of the picture messages you sent or saved displays.

1. Select a message and press the **Select** soft key to view the message contents.
2. To scroll through the message, press the **Left** or **Right** key.

While viewing a message, you can choose the following options by pressing the **Options** soft key:

**Delete:** deletes the message.

**Cut Address:** allows you to extract the destination number from the message, so that you can call the number save it in your Phonebook.

**Send:** allows you to resend the message.

**Edit Message:** allows you to change the message contents, sound, picture or text.

## Shop MMS

This option allows you to access the Cingular website to purchase additional multi-media messages (MMS).

## Write New

This menu option allows you to create a new picture message and then send it to multiple destinations.

## Creating and Sending a Picture Message

1. Enter the subject of your message and press the **OK** soft key.

2. When **Add Here** highlights, press the **Options** soft key and add the message contents using one of the following options:

- **Add Text:** Enter the message text and press the OK soft key.
- **Add My Photo:** allows you to add a photo you took using the camera on your phone. Select a photo and press the **View** soft key. Then, press the **Select** soft key to add. For further details about using the camera, see “Camera” on page 93.
- **Add Picture:** allows you to add a picture stored in the **Pictures** folder in the **Downloads** menu. Choose a picture and press the **Select** soft key.
- **Send:** allows you to send the message. Use this option when you finish creating the message. This option is activated after you add a content to the message.
- **Save:** allows you to save the message in the Outbox so that it can be sent later.

3. When the added content displays, press the  key to highlight **Add Here**.

4. Repeat steps 2 and 3 until you finish creating your message.

5. If you want to change the added items, press the Up or Down key to highlight one and press the **Options** soft key. The following options are available:

- **Edit** allows you to change text or replace the image with another one.
- **Delete:** deletes the item from your message.

- **Send:** allows you to send the message.
  - **Save:** allows you to save the message in the Outbox so that it can be sent later.
6. When you finish creating the message, select **Send** from the options.
  7. Choose one of the following options and press the **Select** soft key:
    - **Phone Number:** allows you to enter the phone number you want.
    - **E-Mail:** allows you to enter the e-mail address of the recipient to send the message as an e-mail.
    - **Phone Book:** allows you to recall a number from your Phonebook.
  8. Enter a number or an e-mail address, or select a number in Phonebook. When the correct number or address is displayed, press the **OK** soft key.
  9. If you want to send the message to multiple destinations, select **Add Destination** and press the **Select** soft key.
  10. Repeat steps 7 to 10. You can enter up to 11 destinations.
  11. After entering the destinations, press the **Select** soft key when **Send Message** highlights.
  12. If you want to edit the destinations, select one and press the **Select** soft key. You can change or delete it.

13. When you are finished entering the destinations, select **Send Message** and press the **Select** soft key. Your phone sends the message.

## Delete All

This menu option allows you to delete all of the picture messages in each message box, Inbox, and Outbox.

When a confirming message displays, press the **Yes** soft key to confirm.

## Setup

You can change the default message settings.

Turn a given option on or off, press the **Select** soft key to place or remove a check mark on each option

The following options are available:

**Hide ID:** When this option is checked, your phone number is not displayed on the recipient's phone.

**Delivery Report:** When this option is checked, the network informs you whether or not your message has been delivered.

**Read Reply:** When this option is checked, your phone sends a request for a reply along with your message to the recipient.

**Auto Download:** When this option is checked, your phone automatically downloads the received pictures or sounds.

## MMS Profile

In this menu, you can configure various settings that are required when you send or receive multimedia messages.

The following options are available:

**Profile Name:** Name that you wish to assign to the MMS server.

**Connection URL:** Address of your MMS server.

**Security:** Data transmission mode. Choose **Secure** to protect your data against unauthorized access; otherwise, choose **Non-Secure**.

**IP address:** Gateway address required to connect to the MMS server.

**User name:** User ID required to connect to the MMS server.

**Password:** Password required to connect to the MMS server.

**APN:** Access point name used for the address of the MMS server.

For further details, contact your service provider.

# Call Records

In this menu, you can view the:

- Missed, incoming or outgoing calls
- length of the call you made or received
- cost of your calls

**Note:** You can access all numbers in the three types of call records by pressing the  key in idle mode.

## Missed Calls

This option lets you view the last 20 unanswered calls. The number and name, if available, are displayed, together with the date and time at which the call was received. By pressing the **Options** soft key, you can:

- delete the call from the list
- edit the number, if available, and save it in the Phonebook
- make a call to the number

## Incoming Calls

This option lets you view the last 20 phone calls answered. The number and name, if available, are displayed, together with the date and time at which the call was received. By pressing the **Options** soft key, you can:

- Edit the number if available and dial it or save it in the phonebook
- Delete the call from the list
- Make a call to the number.

## Outgoing Calls

This option lets you view the last 20 numbers dialed. The number and name, if available, are displayed, together with the date and time at which the call was made. By pressing the **Options** soft key, you can:

- Delete the number
- Edit the number and save it in the phonebook
- make a call to the number

## Delete All

You can delete all of the numbers stored in each call record.

When a confirming message appears, press the **Yes** soft key to confirm.

## Call Time

This option lets you view the timers for calls made and received.

The following timers are available.

**Last Call Time:** length of the last call.

**Total Outgoing:** total length of all calls made since the timer was last reset.

**Total Incoming:** total length of all calls received since the timer was last reset.

**Reset Timers:** option used to reset the call timers; you must first enter the phone password (see “Phone Password” on page 141) and then press the **OK** soft key.

# Camera

Using the camera module built in your phone, you can take pictures of people or events while on the move.

Additionally, you can send photos to other people in a picture message or as an e-mail attachment. The camera produces JPEG pictures.

## Take and Send



This menu allows you to take a picture to send the photo as a picture message to other destinations.

**Note:** When you take a picture in direct sunlight or under too bright illumination, shading may occur on the picture.



## Taking a Picture to Send a Message

1. Accessing this menu turns on the camera at the top center of the phone. You can see the picture to be captured on the display.

2. Adjust the picture by rotating the camera module.

Use the  and  keys to adjust the brightness of the picture.

Use the  and  keys to adjust the size of the picture.

The  and  keys on the left side of the phone allow you to flip the picture up and down.

3. Press the **Take** soft key to take a picture.

If you want to have the delay time of 10 seconds, press the **After 10s** soft key.



4. Press the **Save** soft key to save the photo.
5. Enter a name for your photo and press the **OK** soft key.
6. Follow the procedures in “Creating and Sending a Picture Message” on page 86 to send the photo as a picture message.

## New Photo

In this menu, you can take a picture and save it.

Accessing this menu turns on the camera at the top center of the phone.

## My Photos

This menu allows you to review your photos.

When you access this menu, the latest photo is displayed.

Press the **↓** or **↑** key to scroll through the photos.

Pressing the **Multi** soft key shows the photos as thumbnail images on one screen. In thumbnail view mode, use the navigation keys to scroll through the photos. To go back to normal view mode, press the **View** soft key.

Press the **Options** soft key to use the following options:

**Send:** allows you to send the photo as a picture message.

**Wallpaper:** allows you to set the photo to be displayed on the idle screen as a background image.

**Delete:** deletes the photo.

**Deletes All:** deletes all of the photos saved in your phone.

**Rename:** allows you to change the name of the photo.

# Sound Settings

You can use the Sound Settings feature to customize various settings, such as the:





- Ring melody, volume and type
- Sounds made when you press a key, make an error or receive a message

## Ring Tone

This option allows you to select the required ring melody. You can choose between many different melodies. Each time you select a melody, it is played for a few seconds. If you have downloaded any sounds from the Internet or Escapers program or received any ring tone messages, you can view the list in this menu.

## Ring Volume

This option allows you to adjust the ring volume to one of five levels.

Use the  and  keys or the  and  keys on the left side of the phone.

## Shop Ringtones

This option allows you to access the Cingular website to purchase additional ringtones.

## Alert Type

This option allows you to specify how you are to be informed of any incoming calls.

The following options are available.

**Light only:** only the backlight is switched on; the phone neither rings nor vibrates.

**Melody:** the phone rings using the ring melody selected via the

**Vibration:** the phone vibrates but does not ring.

**Vibra+Melody:** the phone first vibrates three times and then starts ringing.

## Keypad Tone

This option allows you to select the tone that the keypad generates when you press a key.

The following options are available.

**Off:** the keys do not make any sound.

**Cool:** each key, when pressed, makes the same sound but is a different tone from the Beep option.

**Piano:** each key, when pressed, plays the piano melody.

**Tone:** each key, when pressed, makes a different sound.

**Beep:** each key, when pressed, makes the same sound.

## Message Tone

This option allows you to select how the phone informs you that a new message has been received.

## SMS Tone

This option allows you to select how the phone informs you that a new SMS message has been received.

The following options are available.

**SMS Tone1~10:** the phone uses an SMS tone. You are provided with ten SMS tones.

**OFF:** the phone does not use the SMS tone.

**Light Only:** the service light at the top of the phone flashes.

**Vibration:** the phone vibrates.

**Single Beep:** the phone beeps once.

## SMS CB Tone

This option allows you to select how the phone informs you that a new cell broadcast (CB) message has been received.

The following options are available.

**OFF:** the phone does not use the CB tone.

**Light Only:** the service light at the top of the phone flashes.

**Vibration:** the phone vibrates.

**Single Beep:** the phone beeps once.

**SMS-CB Tone1~10:** the phone uses a CB tone. You are provided with ten CB tones.

## Folder Tone

This option allows you to choose the sound when opening and closing the folder.

Three options are **Off**, **Future**, and **Crystal**. To turn the sound off, select **Off**.

## Power On/Off

Use this option to choose the sound you prefer when turning your phone on or off. Three options are **Off**, **Classical**, and **Cheerful**.

## Extra Tones

You can customize various other tones used by the phone.

| To turn a given tone... | Then press the...  |
|-------------------------|--|
| On                      | <b>On</b> soft key.<br>A check mark is displayed in front of the option. |
| Off                     | <b>Off</b> soft key again.<br>The check mark is no longer displayed.     |

The following options are available.

**Error Tone:** sets whether the phone informs you that you have made a mistake or not.

**Minute Minder:** sets whether the phone must beep every minute during an outgoing call to keep you informed of the length of your call.

**Connect Tone:** sets your phone to beep when the person you are calling answers the phone.

# Phone Settings

Many different features of your phone can be customized to suit your preferences. All of these features are accessed via the **Phone Settings** menu.

## Infrared Activate

Infrared Activate provides use of your phone as a modem or to synchronize to the EasyGPRS application. This feature allows you to send or receive data through the infrared port. To use an infrared connection, you must:

- configure and activate an IrDA-compliant infrared port on your PC.
- activate the infrared feature on the phone; the IrDA icon appears on the top line of the display.
- align the IrDA port on the phone with the IrDA port on your computer.

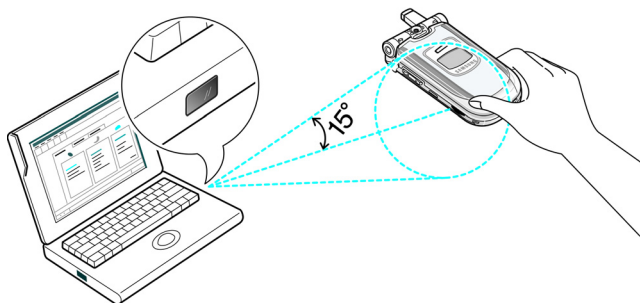

The connection is ready for data transmission.

If there is not communication between your phone and the IrDA-compliant device within 30 seconds of activating the feature, it is automatically deactivated.

**Note:** For the best performance, use the optional data link cable. You can buy one from your local Samsung dealer.



## My Settings

You can change the background image and the color of the components in the display according to your preference.

## Wallpaper

This option allows you to change the background image (wallpaper) to be displayed in idle mode.

To change the background image, proceed as follows.

1. Scroll through the list by pressing the  or  key.

You have various preset images available. You can also select the blank background and any images downloaded from the Internet or the EasyGPRS program.

2. Press the **Select** soft key when the required image is highlighted.

The selected image is displayed.

3. After viewing the image, press the **Select** soft key to display it on the idle screen. The display asks you if you want to display text on the screen.

## Menu Style

This option allows you to select the menu display style. You can choose between **Film Style** and **Page Style**.



## Shop Graphics

This option allows you to access the Cingular website to purchase additional graphics.



## Greeting Message

This option allows you to set a greeting message to be displayed briefly when the phone is switched on. The current message is displayed.

| To...                      | Then press the...  |
|----------------------------|--|
| Clear the existing message |  key and hold it down until the message is cleared. |
| Enter a new message        | Appropriate alphanumeric keys.   |
| Change the text input mode |  soft key.  |

For further details on how to enter characters, refer to “Entering Text” on page 51.

## Own Number

This feature allows you to:

- Assign a name to each of your own phone numbers registered on your SIM card

This function is a memory aid, which you can use to check your own phone numbers if you need to do so.

Any changes made here do not in any way affect the actual subscriber numbers on your SIM card.

## Language

You can select a display language. When the language option is set to **Automatic**, the language is automatically selected according to the language of the SIM card used.

## Security

The Security feature enables you to restrict the use of your phone to:

- The people of your choice
- The types of calls of your choice

Various codes and passwords are used to protect the features of your phone.

## PIN Check

When the PIN Check feature is enabled, you must enter your PIN each time you switch the phone on.

Consequently, any person who does not have your PIN cannot use your phone without your approval.

**Note:** Before disabling the PIN Check feature, you must enter your PIN.

To change your PIN, refer to the **Change PIN** menu option. The following options are available.

**Disable:** the phone connects directly to the network when you switch it on.

**Enable:** you must enter the PIN each time the phone is switched on.

## Change PIN

This feature allows you to change your current PIN to a new one, provided that the PIN Check feature is enabled. You must enter the current PIN before you can specify a new one.

Once you have entered a new PIN, you are asked to confirm it by entering it again.

## Phone Lock

When the Phone Lock feature is enabled, the phone is locked and you must enter the 8-digit phone password each time the phone is switched on.

The password is factory set to “00000000”. To change the phone password, refer to the **Change Password** menu option.

Once the correct password has been entered, you can use the phone until you switch it off.

The following options are available.

**Disable:** you are not asked to enter the phone password when you switch the phone on.

**Enable:** you are required to enter the phone password when you switch the phone on.

## Change Password

The Change Password feature allows you to change your current phone password to a new one. You must enter the current password before you can specify a new one.

The password is factory set to “00000000”. Once you have entered a new password, you are asked to confirm it by entering it again.

## SIM Lock

The SIM Lock feature allows you to lock your phone so that others are unable to use it. When the SIM Lock feature is enabled you must enter the password that you assigned to use your phone. Options available are:

**Disable:** you are not asked to enter the SIM Lock password when you switch the phone on.

**Enable:** you are required to enter the SIM Lock password when you switch the phone on.

## FDN Mode

The FDN (Fixed Dial Number) mode, if supported by your SIM card, allows you to restrict your outgoing calls to a limited set of phone numbers.

The following options are available.

**Disable:** you can phone any number.

**Enable:** you can only call phone numbers stored in the phonebook. You must enter your PIN2.

**Note:** Not all SIM cards have a PIN2. If your SIM card does not, this menu option is not displayed.

To change your PIN2, refer to the **Change PIN2** menu option.

## Change PIN2

The Change PIN2 feature allows you to change your current PIN2 to a new one. You must enter the current PIN2 before you can specify a new one.

Once you have entered a new PIN2, you are asked to confirm it by entering it again.



**Note:** Not all SIM cards have a PIN2. If your SIM card does not, this menu option is not displayed.

## Display Settings

### Brightness

This option allows you to adjust the contrast of the display and make it lighter or darker.

To adjust the display contrast:

1. Select the required display, **Main LCD** or **Front LCD**, and press the **Select** soft key.
2. Adjust the contrast using the  and  keys, and press the **Select** soft key.
3. When you have made your choice, press the **OK** soft key to save the selection.

### Back Light

You may choose whether or not the phone uses the backlight. marginal increase in standby/talk time can be achieved by turning the backlight off.

Select the length of time the backlight is on. Available settings are **OFF, 15 or 30 seconds, 1, 3, or 10 minutes**. The backlight comes on when you press a key or receive a call or message and remains illuminated for the specified length of time.

### Auto Light

Using this feature, you can specify the time for which the backlight is to be used. This feature helps conserve your battery power.

The following options are available:

**Disable:** the backlight is used according to the setting in the **Back Light** menu option.

**Enable:** the backlight is used only during the specified period of time. Set the time when the phone will turn on the light and turn it off, using the appropriate number keys.

## Service Light

This option allows you to select whether or not the service light on the folder is used or which color is flashes.

Select one from the seven settings available. When the phone is ready for use, the service light flashes in the appropriate color.

## Graphic Logo

This option allows you to display your operator's logo instead of its name.

**On:** the operator logo stored in your phone is displayed in idle mode; if no logo has been stored, the operator name is displayed.

**Off:** the operator name is displayed in the idle mode.

## Extra Settings

You can turn the automatic redialing or answering features on or off.

To turn a feature...

Then press the...

On

**ON** soft key.

A check mark is displayed in front of the option.

To turn a feature...

Then press the...

Off

**OFF** soft key.  
The check mark is no longer displayed.

The following options are available.

**Auto Redial:** when this option is checked, the phone makes up to ten attempts to redial a phone number after an unsuccessful call.

**Note:** The interval between two call attempts varies.

**Active Folder:** when this option is checked, you can simply press any key to answer the incoming call.



**Anykey Answer:** when this option is checked, you can answer an incoming call by pressing any key, except the **Reject** soft key. To reject the call, press the  key or the **Reject** soft key.

When this option is unchecked, you can only press the  key or **Accept** soft key.

## ShortCut

The navigation keys can be used as shortcut keys. When held down in idle mode, they allow you to access specific menu options directly.



To assign a shortcut to a key, proceed as follows.

1. Select the key to be used as a shortcut key by pressing the  or  key, followed by the **Select** soft key.

**Key up** (  )

**Key right** (  )

## Key left ( )

2. Select the menu option to be assigned to the key by pressing the  or  key.

**Note:** To deactivate a shortcut key, select the **None** option.

3. Press the **Select** soft key to save the selection.

## TTY Setting

TTY (also known as a TDD or Text Telephone) is a telecommunications device that allows people who are deaf or hard of hearing, or who have speech or language disabilities, to communicate via a telephone.

Your phone is compatible with select TTY devices which have an internal CTM. Please check with the manufacturer of your TTY device for connectivity information and to ensure that the TTY device supports digital wireless transmission.

The following options are available:

**Enable:** CTM is active and TTY is available for use.

**Disable:** TTY is not available for use.

**Note:** For additional technical support you may access the following website or call 1-888-987-4357.

[http://www.samsungtelecom.com/contact\\_us/accessibility.asp](http://www.samsungtelecom.com/contact_us/accessibility.asp)



## Reset Settings

You can easily reset your phone to its default configuration. To do so, proceed as follows.

1. Select the **Reset Settings** menu option.
2. Enter the 8-digit phone password and press the **OK** soft key.

**Note:** The password is preset to "00000000". To change this password, refer to "Change Password" on page 104.

# Organizer

The Organizer feature enables you to:

- View the calendar and organize your schedule
- Define a list of things to do
- Set the current date and time
- Set the alarm so that the phone rings at a specific time (to remind you of an appointment for example)
- Use the phone as a calculator for basic mathematical equations or currency exchange operations



## Calendar

With the Calendar feature, you can:

- Consult the calendar
- Write memos to keep track of your schedule and trigger an alarm if necessary

## Consulting the Calendar

When you select the **Calendar** menu option, the calendar is displayed. The following options are available when you press the **Options** soft key.

**Search all:** displays all memos set, regardless of the day and starting with the oldest. To scroll through the memos, press the  or  key.

**Delete all:** allows you to delete all memos. You are asked to confirm your action.

**Go to date:** allows you to jump to a specific date.

**Exit:** exits the Calendar feature and returns to the idle mode.

## Writing a Memo

To write or edit a memo on a specific date, proceed as follows.

1. Select the required date in the calendar, using the navigation keys.

**Note:** To skip to the previous or next month, press the ▲ and ▼ keys on the left side of the phone.

2. Press the **Select** soft key.

An empty memo screen is displayed to allow you to enter your memo.

3. Enter your memo and then press the **OK** soft key.

**Note:** For further details on how to enter characters, refer to “Entering Text” on page 51.

You are asked if you wish to set the alarm.

4. If you want the alarm to ring on the chosen day, press the **Yes** soft key. Otherwise, press the **No** soft key.
5. If you pressed the **Yes** soft key, set the time for the alarm and press the **OK** soft key.  
The color of the date is changed to green to indicate that a memo exists.

## Editing a Memo

If you select a day for which a memo already exists, you can press the **Edit** soft key to edit the memo displayed.

Once you have finished editing the memo, press the **OK** soft key. The following options are then available when you press the **Options** soft key.

**Alarm:** allows you to set the alarm to ring on the chosen day.

**Erase:** allows you to delete the memo.

**Copy to:** allows you to copy the memo to another date and/or time.

**Move to:** allows you to change the date and/or time of the memo.

1. To edit a memo, select the **Calendar** menu option.
2. Select the date your memo is set to occur by using the right and left arrow keys. Press the **Select** soft key.
3. Press the **Options** soft key.
4. Select the **Edit** menu option and edit the memo appropriately.

## To Do List



This feature allows you to:

- Draw up a list of tasks to be done
- Assign a priority and deadline to each task
- Sort the tasks by priority and status mark

## Creating the To Do List

1. Press the **New** soft key.
2. Enter the first task.

**Note:** You can enter up to 40 characters. For further details on how to enter characters, see “Entering Text” on page 51.

3. Press the **OK** soft key.
4. Select high, normal or low priority using the  or  key and press the **Select** soft key.
5. Enter your deadline.

If you do not want to set a deadline, press the **Skip** soft key.

6. Press the **OK** soft key.

## Editing the To Do List

If tasks are already defined in the To Do List when you select the **To Do List** menu option, the current contents are displayed with the status mark and priority.

The following options are available.

| To...                                | Then...  |
|--------------------------------------|--|
| View the details for a specific task | Highlight the task.<br>Press the <b>View</b> soft key. |

| To...   | Then...  |
|---|--|
| Change the status of a specific task          | <p>Highlight the task.</p> <p>Press the  key to mark the task as completed as of the current date and time.</p> <p>or</p> <p>Highlight the task.</p> <p>Press the <b>Options</b> soft key.</p> <p>Select the <b>Mark</b> option.</p> <p>Select the appropriate status (<b>Done</b> or <b>Undo</b>).</p> |
| Create a new task                             | <p>Press the <b>Options</b> soft key.</p> <p>Select the <b>New</b> option.</p> <p>Enter the text, priority and deadline for the task.</p>  |
| Edit an existing task                         | <p>Highlight the task.</p> <p>Press the <b>Options</b> soft key.</p> <p>Select the <b>Edit</b> option.</p> <p>Change the text, priority and deadline for the task.</p>   |
| Sort the existing tasks by priority or status | <p>Press the <b>Options</b> soft key.</p> <p>Select the <b>Sort</b> option.</p> <p>Select the sort criterion (<b>High</b>, <b>Low</b>, <b>Done</b> or <b>Undo</b>).</p>  |

| To...                       | Then...   |
|-----------------------------|---|
| Copy a task                 | Highlight the task.<br>Press the <b>Options</b> soft key.<br>Select the <b>Copy</b> option.<br>Change the text, priority and deadline for the task as required.                     |
| Copy a task to the calendar | Highlight the task.<br>Press the <b>Options</b> soft key.<br>Select the <b>Copy to calendar</b> option.<br>Change the text and deadline for the task and set the alarm as required. |
| Delete a task               | Highlight the task.<br>Press the <b>Options</b> soft key.<br>Select the <b>Delete</b> option.   |
| Delete all tasks            | Press the <b>Options</b> soft key.<br>Select the <b>Delete all</b> option.<br>Confirm the deletion by pressing <b>OK</b> .  |
| Exit the To Do list         | Press the <b>Options</b> soft key.<br>Select the <b>Exit</b> option.  |

## Time & Date

This option allows you to change the current time and date displayed. You can also check the current time for Greenwich Mean Time (GMT) and 21 major cities around the world.

The following options are available.

**Set Time:** allows you to enter the current time. You can choose the time format via the **Time Format** menu option.

**Note:** Before setting the time, you must specify your time zone, via the **World Time** menu option (**Menu 7.3.3**).

**Set Date:** allows you to enter the day, month and year.

**World Time:** allows you to check the current time for Greenwich Mean Time (GMT) and 21 major cities around the world, using the **↵** and **↩** keys.

The screen shows the:

- City name
- Current date and time
- Time difference between the selected city and your city if you have set the local time (see below for further details) or GMT (by default)

To select the time zone in which you are located, proceed as follows.

1. Select the city corresponding to your time zone by pressing the **↵** or **↩** key one or more times.

The local date and time are displayed.

2. Press the **Set** soft key.

**Time Format:** allows you to change the time format to **24 Hours** or **12 Hours**.



## Alarm

This feature allows you to:

- Set the alarm to ring at a specific time
- Set the phone to switch on automatically and ring the alarm even if the phone is switched off (**Auto power** menu option set to **Enable**)

The following options are available.

**Once Alarm:** the alarm rings only once and is then deactivated.

**Daily Alarm:** the alarm rings every day at the same time.

**Morning Call:** the alarm rings to wake you up in the morning.

To set the alarm, proceed as follows.

1. Choose the type of alarm to be set.
2. Enter the required time and day of the week, if applicable.
3. Press the **OK** soft key.
4. If you select **Morning Call** in Step 1, select the repeat option: **Monday to Friday** or **Monday to Saturday**.

**Remove Alarm:** deactivates all alarm settings.

**Auto power:** if this option is set to **Enable**, the alarm will ring at the specified time, even when the phone is switched off.

If the menu option is set to **Disable** and the phone is switched off at the specified time, the alarm will not ring.

To stop the alarm when it rings, press the **Exit** soft key.

When setting or viewing an alarm, the following options are available when you press the **Options** soft key.

**Remove Alarm:** deactivates the current alarm.

**Alarm Sound Set:** allows you to select the alarm melody this option can be found in each of the Alarm options.

## Calculator



With this feature, you can use the phone as a calculator. The calculator provides the basic arithmetic functions: addition, subtraction, multiplication and division.

### Using the Calculator

1. Enter the first number using the numeric keys.
2. Press the right soft key until the required arithmetic symbol appears: + (add), - (subtract), \* (multiply), / (divide).
3. Enter the second number.

Repeat Steps 1 to 3 as many times as required.

Notes:

- To erase any mistakes and clear the display, press the  key.
  - To include a decimal point or a bracket, press the left soft key until the required symbol is displayed.
4. To calculate the result, press the  key.

## Currency Exchange

Using this menu option, you can make currency conversions.

1. Enter the current exchange rate of your source currency and press the **OK** soft key.

You can insert a decimal point by pressing the  key.

2. Enter the amount for which you wish to conduct the currency conversion and press the **OK** soft key.

The exchange rate amount you entered and equivalent value are displayed.

3. Press the **Exit** soft key to exit the currency convertor.

# Network Services

These menu functions are network services. Please contact your service provider to check their availability and subscribe to them, if you wish.

## Call Forwarding

This network service enables incoming calls to be rerouted to the number that you specify.

Example: You may wish to forward your business calls to a colleague while you are on holiday.

Call forwarding can be set up in the following ways:

**Forward Always:** all calls are forwarded.

**Busy:** calls are forwarded when you are already on another call.

**No Reply:** calls are forwarded when you do not answer the phone.

**Unreachable:** calls are forwarded when you are not in an area covered by your service provider.

**Cancel All:** all call forwarding options are canceled.

You can specify individual forwarding options for each of the following call types:

- Voice calls only
- Data calls only

To set your call forwarding options:

1. Select the type of call forwarding by pressing the Up or Down key, and then press the **Select** soft key.
2. Select the type of calls to be forwarded by pressing the Up or Down key, and then press the **Select** soft key.

The current status displays. If the option has already been set, the number to which the calls are forwarded displays.

| To                         | Press the                                  |
|----------------------------|--|
| activate call forwarding   | <b>Activate</b> soft key.<br>Go to Step 4. |
| change the call number     | Change soft key.<br>Go to Step 4.          |
| deactivate call forwarding | <b>Remove</b> soft key.                    |

3. Enter the number to which the calls are to be forwarded and press the **OK** soft key.  
To enter an international code, press the **0** key until the + sign displays.

The phone sends your settings to the network and the network's acknowledgement displays.

You can deactivate all call forwarding settings by selecting the **Cancel All** option.

## Call Barring

The call barring network service allows you to restrict your calls.

Call barring can be setup in the following ways:

**All Outgoing:** calls cannot be made.

**International:** International calls cannot be made.

**International Except to Home:** when abroad, calls can be made on to numbers within the current country and to

your home country, which is the country where your home network provider is located.

**All Incoming:** calls cannot be received.

**Incoming While Abroad:** calls cannot be received when you are using your phone outside of your home service area.

**Cancel All:** all call barring setting are deactivated; calls can be made and received normally.

You can specify individual barring options for each of the following call types:

- Voice calls only
- Data calls only

To set your call barring options:

1. Select the type of call barring required by pressing the **Left** or **Right** key until the appropriate option highlights and then press the **Select** soft key.
2. Select the type of calls to be barred by pressing the **Left** or **Right** key until the appropriate option highlights and then press the **Select** soft key.
3. Press **Activate** soft key to confirm your settings.
4. Enter your call barring password supplied by your service provider.

The phone sends your settings to the network and the network's acknowledgment displays.

To deactivate specific call barring settings:

1. Select the call barring option to be deactivated.
2. Select the type of call to which this option applies.

3. Press the **Deactivate** soft key.
4. Enter your call barring password supplied by your service provider.

The phone sends your settings to the network and the network's acknowledgement displays.

You can also deactivate all call barring settings by selecting the **Cancel All** option.

**Change Barring Password:** you can set and change the call barring password obtained from your service provider using this option. You must enter the current password before you can specify a new one.

Once you have entered a new password, you are asked to confirm it by entering it again.



## Call Waiting

This network service informs you when someone is trying to reach you during another call.

You can specify individual call waiting options for each of the following call types:

- Voice calls only
- Data calls only

To set your call waiting options:

1. Select the type of calls to which the call waiting option is to be applied by pressing the  or  key, and then press the **Select** soft key.

The screen informs you whether call waiting is activated or deactivated.

2. You can activate or deactivate the call waiting feature as necessary by using the **Activate** or **Deactivate** soft key respectively.



To return to the previous screen, press the **Exit** soft key. You can also deactivate all call waiting settings by selecting the **Cancel All** option.

## Network Selection

The Network Selection feature enables you to automatically or manually select the network used when roaming outside of your home area.



**Note:** You can select a network other than your home network only if there is a valid roaming agreement between them.

To indicate to automatically or manually select the network when roaming:

1. When **Network Selection** displays, press the **Select** soft key.
2. Press the  or  key until the appropriate option highlights and then press the **OK** soft key.

If you select **Automatic**, you are connected to the first available network when roaming.

If you select **Manual**, the phone scans for the available networks. Go to Step 3.

3. Press the  or  key until the preferred network highlights and then press the **OK** soft key.

You are connected to that network.



## Caller ID

You can prevent your phone number from being displayed on the phone of the person being called.

**Note:** Some networks do not allow the user to change this setting.

The following options are available:

**Default:** the default setting provided by the network is used.

**Hide Number:** your number does not display on the other person's phone.

**Send Number:** your number is sent each time you make a call.

## Closed User Group (CUG)

This network service allows incoming and outgoing calls to be restricted to a selected user group. You may be a member of up to ten user groups. For details on how to create, activate and use a closed user group, contact our service provider.



Example: A company lends SIM Cards to its employees and wants to restrict outgoing calls to members of the same team.

## Activating a Closed User Group

If you select the Closed User Group menu, you can enter the CUG function. You can now access the following options after pressing the Select soft key.

**Index List:** lets you list, add or delete CUG index numbers. The list of current CUG indexes appears.

Add a new CUG index as advised by your service provider or delete the selected group.

| To                                    | Press the   |
|---------------------------------------|---|
| scroll through the existing CUG index |  or  key. |
| add a new CUG index                   | <b>Options</b> soft key, select the <b>Add</b> option and enter the index.  |
| delete a CUG                          | <b>Options</b> soft key and select the <b>Delete</b> option.  |
| activate a CUG index                  | Options soft key and select the <b>Activate</b> option.   |

**Outside Access:** lets you enable or disable calls to numbers other than those nominated for the Closed User Group. This feature depends on the nature of your CUG subscription. Please check with your service provider.

**Default Group:** you may set a default CUG with your service provider. If you have done so, you can enable the Default Group option on your phone. When making a call, you are given the option of using your default CUG, instead of selecting one from the list.

**Deactivate:** deactivates the CUG function. This menu appears only when the default group is enabled or a CUG index is selected.





# Funbox

The **Funbox** menu contains several fun options.

## Games

You can enjoy three games with your phone.



Scroll to the required game, using the  and  keys and press the **Select** soft key. For further details on the game, refer to the on-screen help.

## WAP Browser

Your phone is equipped with a WAP (Wireless Application Protocol) browser to allow you to access and navigate the Wireless Web via your phone.



## Home

Selecting this option connects the phone to the network and loads the homepage of the Wireless Web service provider.





The content of the WAP Browser startup homepage depends on your Wireless Web service provider. To scroll through the screen, use the  and  keys.

**Note:** To access the startup homepage from any other screen in the WAP Browser, use the **Home** option. For more information on the WAP Browser menus, see page 131.

## Exiting the WAP Browser



To exit the browser at any time, simply press the  key or press and hold the  key.

## Navigating the WAP Browser



| To                                      | Press the  |
|---|--|
| scroll through and select browser items |  or  key until the  symbol points to the required item, and then press the <b>OK</b> soft key to confirm the selection. |
| select a numbered item                  | corresponding numeric key.   |
| return to the previous page             | <b>Back</b> soft key or the  key.   |
| return to the startup homepage          |  key and select the <b>Home</b> menu option. For further details about this option, see page 131.   |

## Entering Text in the WAP Browser

When you are prompted to enter text, the current text entry mode is indicated on the screen. The following modes are available:

| Mode  | Description  |
|---|--|
|  | Allows you to enter letters in the alphabet. Press the corresponding key until the letter you want displays. |
|  | Allows you to enter numbers.   |





**Note:** To enter a symbol, press the  key until it displays.

|                  |   |
|------------------|---|
| To change modes  | press the <b>i</b> key one or more times.   |
| To enter a space | press the  key.  |
| To edit text     | set the cursor to the right of the character(s) to be corrected.<br>press the  key as required.<br>enter the correct character(s). |

## Using and Selecting Menu Options

Various menu options are available when you are using the WAP Browser to navigate the Wireless Web.

To access a menu option:

1. Press and hold the  key.  
A menu displays.
2. Highlight a menu option by pressing the  and  keys.
3. Select the option by pressing the **Select** soft key.
4. If necessary, select the secondary option using the  and  keys, and press the **Select** soft key to confirm.

**Note:** The menus may vary, depending on your version of the WAP Browser.

The following options are available:

**Reload:** reloads the current page.

**Home:** takes you back at any time to the homepage of the Wireless Web service provider.

**Go to URL:** allows you to manually enter the URL address of the required Web page. After entering an address, press the **OK** soft key to go there directly.

**Show URL:** displays the URL address of the site to which you are currently connected. It also enables you to declare the current site as the startup homepage.

| To  | Press the   |
|---|---|
| declare the current page as your startup homepage | <b>Option</b> soft key, select the <b>Save to Home</b> option and press <b>Select</b> .     |
| set a bookmark for the current page               | <b>Option</b> soft key, select the <b>Save to Bookmark</b> option and press <b>Select</b> . |
| cancel your setting                               | <b>Back</b> soft key.   |

**Edit Home:** allows you to change the startup homepage manually. Enter the required URL and press the **OK** soft key. For more information about entering text, numbers or symbols, see page 130.

**Inbox:** allows you to read the messages received from the web server.

## Favorites

This menu option allows you to store the URL addresses of your favorite web sites. You can access this menu

directly by pressing and holding down the  key while using the WAP Browser.

To store a URL address:

1. Select an empty location and press the **Options** soft key.

2. Enter the address and press the **Enter** soft key.

Note: For further details about how to enter characters, page 51.

3. Enter a name for the favorite item and press the **Enter** soft key.

After saving favorite items, you can use the following options by pressing the **Options** soft key:

**Goto URL:** quickly accesses you to the site.

**Edit:** allows you to edit the address.

**Erase:** deletes the address.

## http://

This menu option allows you to manually enter the URL address of the web site that you wish to access.

For further details about entering characters, see page 51.

## Settings

This option allows you to set up five proxy servers for the WAP browser. Contact your service provider for details about setting options.

For each server, the following options are available:

**Profile Name:** enter a name that you wish to assign to the HTTP proxy server.



**Homepage URL:** set the address of your startup homepage. When the default homepage displays, you can delete it using the  key and enter your own choice.

**Security:** set the data transmission mode. Choose **Secure** to protect your data against unauthorized access; otherwise, choose **Non-Secure**.

**IP Address:** enter the WAP gateway address required to connect to the Internet.

**Bearer:** select the bearer to be used for each type of network address accessed: **GPRS** or **Data**. The remaining options depend on the **Bearer** setting.

When the bearer is set to **Data**

**Login Name:** enter the PPP server login ID.

**Password:** enter the **PPP** server password.

**Dial-up Number:** enter the PPP server phone number.

**Data Call Type:** select a data call type from **Analogue** or **ISDN**.

When the bearer is set to **GPRS**

**User Name:** enter the User ID required to connect to the GPRS network.

**Password:** enter the password required to connect to the GPRS network.

**APN:** enter the access point name used for the address of the GPRS network gateway.

**Note:** The WAP Browser settings may vary, depending on the service provider. Contact your service provider for further information.

## Clear Cache

You can clear the information stored in the cache, which is the phone's temporary memory which stores the most recently accessed Web pages.

Press the **Yes** soft key to confirm the deletion. Otherwise, press the **No** soft key.

## Push Message

This menu option allows you to receive and access web messages from the server.

The following options are available:

**Inbox:** allows you to read the messages received from the web server.

**Receive:** allows you to set whether or not your phone receives web messages.

**Delete All:** allows you to delete all of the web messages.

## Downloads

### Sounds

In this menu, you can view the list of sounds downloaded from the server. You can set the downloaded sounds as the current ring tone, but you cannot send the sounds to other phones.

When the memory is full, a warning message displays and the phone rejects additional sounds until you erase the obsolete ones.

## Pictures

In this menu, you can view the list of pictures downloaded from the server. You can set the downloaded pictures as the current background image, but cannot send them to other phones.

When the memory is full, a warning message displays and the phone rejects additional pictures until you delete the obsolete ones.

# Solving Problems

Before contacting the after-sales service, perform the following simple checks. They may save you the time and expense of an unnecessary service call.

When you switch your phone on, the following messages may appear:

## Insert SIM Card

- Check that the SIM card is correctly installed.

## Phone Locked Enter Password

- The automatic locking function has been enabled. You must enter the phone's password before you can use the phone.

## Enter PIN

- You are using your phone for the first time. You must enter the Personal Identification Number (PIN) supplied with the SIM card.
- The PIN Check feature is enabled. Every time the phone is switched on, the PIN has to be entered. To disable this feature, use the **PIN Check** menu option (**Menu 6.6.1**).

## Enter PUK

- The PIN code was entered incorrectly three times in succession and the phone is now blocked. Enter the PUK supplied by your network operator.

## **“No service,” “Network failure” or “Not done” displays.**

- The network connection was lost. You may be in a weak signal area (in a tunnel or surrounded by buildings). Move and try again.
- You are trying to access an option for which you have not taken out a subscription with your service provider. Contact the service provider for further details.

## **You have entered a number but it was not dialed**

- Have you pressed the  key?
- Are you accessing the right cellular network?

## **Your correspondent cannot reach you**

- Is your phone switched on (the  key pressed for more than one second)?
- Are you accessing the right cellular network?

## **Your correspondent cannot hear you speaking**

- Have you switched off the microphone?
- Are you holding the phone close enough to your mouth? The microphone is located at the bottom of the phone.

## **The phone starts beeping and “\*\*Warning\*\* Low Battery” flashes on the display**

- The battery is insufficiently charged. Replace the battery and recharge it.

## The audio quality of the call is poor

- Check the signal strength indicator on the display (📶); the number of bars indicates the signal strength from strong (📶) to weak (📶).
- Try moving the phone slightly or moving closer to a window if you are in a building.

## No number is dialed when you recall a Phonebook entry

- Check that the number has been stored correctly, by using the Phonebook Search feature.
- Re-store the number, if necessary.

If the above guidelines do not help you to solve the problem, take a note of:

- the model and serial numbers of your phone
- your warranty details
- a clear description of the problem

Then contact your local dealer or Samsung after-sales service.



# Access Codes

There are several access codes that are used by your phone and its SIM card. These codes help you protect the phone against unauthorized use.

When requested for any of the codes explained below, enter the appropriate code (displayed as asterisks) and press the **OK** soft key. If you make a mistake, press the **C** key one or more times until the incorrect digit is cleared and then continue entering the correct code.

The access codes, except for the PUK and PUK2 codes can be changed using the **Security** menu option (**Menu 6.6**). See “Security” on page 103 for further details.

**Important!** Avoid using access codes resembling emergency numbers, such as 911, so that you do not dial an emergency number accidentally.

## Phone Password

The Phone Lock feature uses the phone password to protect your phone against unauthorized use. The phone password is supplied with the phone and is preset to “00000000” at the factory.

| To   | See                            |
|--|--------------------------------|
| activate/deactivate the Phone Lock feature | “Phone Settings” on page 99.   |
| change the phone password                  | “Change Password” on page 104. |



## PIN

The **Personal Identification Number** or PIN (4 to 8 digits) protects your SIM card against unauthorized use. It is usually supplied with the SIM card.

If you enter an incorrect PIN three times in succession, the code is disabled and cannot be used until you re-enable it by entering the PUK (see below).

| To                                   | See                       |
|--------------------------------------|---------------------------|
| enable/disable the PIN Check feature | “PIN Check” on page 103.  |
| change the PIN                       | “Change PIN” on page 103. |

## PUK

The 8-digit PUK (**PIN Unblocking Key**) is required to change a disabled PIN. The PUK may be supplied with the SIM card. If not, or you have lost it, contact your service provider.

To re-enable your PIN:

1. Enter the PUK and press the **OK** soft key.
2. Enter a new PIN of your choice and press the **OK** soft key.
3. When the **Confirm New PIN** message displays, enter the same code again and press the **OK** soft key.

If you enter an incorrect PUK ten times in succession, the SIM card becomes invalid. Contact your service provider for a new card.

## PIN2

The PIN2 (4 to 8 digits), supplied with some SIM cards, is required to access specific functions, such as setting the maximum cost of a call. These functions are available if supported by your SIM card.

If you enter an incorrect PIN2 three times in succession, the code is disabled and you cannot access the functions until you re-enable it by entering the PUK2.

To change the PIN2, see “Change PIN2” on page 105 (Menu 6.6.7).

## PUK2

The 8-digit PUK2 (**PIN Unblocking Key 2**), supplied with some SIM cards, is required to change a disabled PIN2. If you lose the code, contact your service provider.

To re-enable your PIN2:

1. Enter the PUK2 and press the **OK** soft key.
2. Enter a new PIN2 of your choice and press the **OK** soft key.
3. When the **Confirm PIN2** message displays, enter the same code again and press the **OK** soft key.

If you enter an incorrect PUK2 ten times in succession, you will not be able to access the functions requiring the PIN2. Contact your service provider for a new card.



# Health and Safety Information

## Exposure to Radio Frequency (RF) Signals

Your wireless phone is a radio transmitter and receiver. It is designed and manufactured not to exceed the emission limits for exposure to radio frequency (RF) energy set by the Federal Communications Commission (FCC) of the U.S. Government. These limits are part of comprehensive guidelines and establish permitted levels of RF energy for the general population. The guidelines are based on the safety standards that were developed by independent scientific organizations through periodic and through evaluation of scientific studies.

The standards include a substantial safety margin designed to assure the safety of all persons, regardless of age and health.

The exposure standard for wireless phones employs a unit of measurement known as Specific Absorption Rate (SAR). The SAR limit recommended by the FCC is 1.6W/kg.\*

SAR tests are conducted using standard operating positions specified by the FCC with the phone transmitting at its highest certified power level in all tested frequency bands. Although the SAR is determined at the highest certified power level, the actual SAR level of the phone while operating can be well below the maximum value. This is because the phone is designed to operate at

---

\*. In the U.S. and Canada, the SAR limit for mobile phones used by the public is 1.6 watts/kg (W/kg) averaged over one gram of tissue. The standard incorporates a substantial margin of safety to give additional protection for the public and to account for any variations in measurements.

multiple power levels so as to use only the power required to reach the network. In general, the closer you are to a wireless base station antenna, the lower the power output of the phone.

Before a new model phone is available for sale to the public, it must be tested and certified to the FCC that it does not exceed the limit established by the government-adopted requirement for safe exposure. The tests are performed in positions and locations (e.g., at the ear and worn on the body) as required by the FCC for each model. While there may be differences between the SAR levels of various phones and at various positions, they all meet the government requirement.

The FCC has granted an Equipment Authorization for this model phone with all reported SAR levels evaluated as in compliance with the FCC RF exposure guidelines. SAR information on this model phone is on file with the FCC and can be found under the Display Grant section of <http://www.fcc.gov/oet/fccid> after searching on FCC ID printed in the label on the phone.

FCC certification information for this model phone is attached separation paper.

## For Body Operation

---

For body worn operation, this model phone has been tested and meets the FCC RF exposure guidelines when used with a Samsung-supplied or approved accessory designated for this product or when used with an accessory that contains no metal and that positions the handset a minimum from the body.

The minimum distance for this model phone is written in the FCC certification information from the body. No compliance with the above conditions may violate FCC RF exposure guidelines.

## SAR Values

- Head: 1.13 (W/kg)
- Body-worn: 0.433 (W/kg)

For more information concerning exposure to radio frequency signals, see the following websites:

Federal Communications Commission (FCC)

<http://www.fcc.gov>

Cellular Telecommunications Industry Association (CTIA):

<http://www.wow-com.com>

U.S. Food and Drug Administration (FDA)

<http://www.fda.gov/cdrh/consumer>

World Health Organization (WHO)

<http://www.who.int/peh-emf/en>

## Precautions When Using Batteries

---

- Never use any charger or battery that is damaged in any way.
- Use the battery only for its intended purpose.
- If you use the phone near the network's base station, it uses less power; talk and standby time are greatly affected by the signal strength on the cellular network and the parameters set by the network operator.

- Battery charging time depends on the remaining battery charge and the type of battery and charger used. The battery can be charged and discharged hundreds of times, but it will gradually wear out. When the operation time (talk time and standby time) is noticeably shorter than normal, it is time to buy a new battery.
- If left unused, a fully charged battery will discharge itself over time.
- Use only Samsung-approved batteries and recharge your battery only with Samsung-approved chargers. When a charger is not in use, disconnect it from the power source. Do not leave the battery connected to a charger for more than a week, since overcharging may shorten its life.
- Extreme temperatures will affect the charging capacity of your battery: it may require cooling or warming first.
- Do not leave the battery in hot or cold places, such as in a car in summer or winter conditions, as you will reduce the capacity and lifetime of the battery. Always try to keep the battery at room temperature. A phone with a hot or cold battery may temporarily not work, even when the battery is fully charged. Li-ion batteries are particularly affected by temperatures below 0 °C (32 °F).
- Do not short-circuit the battery. Accidental short-circuiting can occur when a metallic object (coin, clip or pen) causes a direct connection between the + and – terminals of the battery (metal strips on the battery), for example when you carry a spare battery in a pocket or bag. Short-circuiting the terminals may damage the battery or the object causing the short-circuiting.
- Dispose of used batteries in accordance with local regulations. Always recycle. Do not dispose of batteries in a fire.

## Road Safety

---

Your wireless phone gives you the powerful ability to communicate by voice, almost anywhere, anytime. But an important responsibility accompanies the benefits of wireless phones, one that every user must uphold.

When driving a car, driving is your first responsibility. When using your wireless phone behind the wheel of a car, practice good common sense and remember the following tips:

1. Get to know your wireless phone and its features, such as speed dial and redial. If available, these features help you to place your call without taking your attention off the road.
2. When available, use a hands-free device. If possible, add an extra layer of convenience and safety to your wireless phone with one of the many hands-free accessories available today.
3. Position your wireless phone within easy reach. Be able to access your wireless phone without removing your eyes from the road. If you get an incoming call at an inconvenient time, let your voice mail answer it for you.
4. Let the person you are speaking with know you are driving; if necessary, suspend the call in heavy traffic or hazardous weather conditions. Rain, sleet, snow, ice and even heavy traffic can be hazardous.



5. Do not take notes or look up phone numbers while driving. Jotting down a To Do list or flipping through your phonebook takes your attention away from your primary responsibility, driving safely.
6. Dial sensibly and assess the traffic; if possible, place calls when you are not moving or before pulling into traffic. Try to plan calls when your car will be stationary. If you need to make a call while moving, dial only a few numbers, check the road and your mirrors, then continue.
7. Do not engage in stressful or emotional conversations that may be distracting. Make the people with whom you are talking aware that you are driving and suspend conversations that have the potential to divert your attention from the road.
8. Use your wireless phone to call for help. Dial the emergency number in the case of fire, traffic accident or medical emergencies. Remember, it is a free call on your wireless phone!
9. Use your wireless phone to help others in emergencies. If you see a car accident, crime in progress or other serious emergency where lives are in danger, call the emergency number, as you would want others to do for you.
10. If you see a broken-down vehicle posing no serious hazard, a broken traffic signal, a minor traffic accident where no one appears injured, or a vehicle you know to be stolen, call roadside assistance or any other special non-emergency wireless number.

## Operating Environment

---

Remember to follow any special regulations in force in any area and always switch your phone off whenever it is forbidden to use it, or when it may cause interference or danger.

When connecting the phone or any accessory to another device, read its user's guide for detailed safety instructions. Do not connect incompatible products.

As with other mobile radio transmitting equipment, users are advised that for the satisfactory operation of the equipment and for the safety of personnel, it is recommended that the equipment should only be used in the normal operating position (held to your ear with the antenna pointing over your shoulder).

## Electronic Devices

---

Most modern electronic equipment is shielded from radio frequency (RF) signals. However, certain electronic equipment may not be shielded against the RF signals from your wireless phone. Consult the manufacturer to discuss alternatives.

### Pacemakers

Pacemaker manufacturers recommend that a minimum distance of 15 cm (6 inches) be maintained between a wireless phone and a pacemaker to avoid potential interference with the pacemaker. These recommendations

are consistent with the independent research and recommendations of Wireless Technology Research.

Persons with pacemakers:

- should always keep the phone more than 15 cm (6 inches) from their pacemaker when the phone is switched on.
- should not carry the phone in a breast pocket.
- should use the ear opposite the pacemaker to minimize potential interference.

If you have any reason to suspect that interference is taking place, switch your phone off immediately.

## Hearing Aids

Some digital wireless phones may interfere with some hearing aids. In the event of such interference, you may wish to consult your hearing aid manufacturer to discuss alternatives.

## Other Medical Devices

If you use any other personal medical devices, consult the manufacturer of your device to determine if it is adequately shielded from external RF energy. Your physician may be able to assist you in obtaining this information. Switch your phone off in health care facilities when any regulations posted in these areas instruct you to do so. Hospitals or health care facilities may be using equipment that could be sensitive to external RF energy.

## Vehicles

RF signals may affect improperly installed or inadequately shielded electronic systems in motor vehicles. Check with the manufacturer or its representative regarding your vehicle. You should also consult the manufacturer of any equipment that has been added to your vehicle.

## Posted Facilities

Switch your phone off in any facility where posted notices require you to do so.

## Potentially Explosive Environments

---

Switch your phone off when in any area with a potentially explosive atmosphere and obey all signs and instructions. Sparks in such areas could cause an explosion or fire resulting in bodily injury or even death.

Users are advised to switch the phone off while at a refueling point (service station). Users are reminded of the need to observe restrictions on the use of radio equipment in fuel depots (fuel storage and distribution areas), chemical plants or where blasting operations are in progress.

Areas with a potentially explosive atmosphere are often but not always clearly marked. They include below deck on boats, chemical transfer or storage facilities, vehicles using liquefied petroleum gas (such as propane or butane), areas where the air contains chemicals or particles, such as grain, dust or metal powders, and any

other area where you would normally be advised to turn off your vehicle engine.

## Emergency Calls

---

This phone, like any wireless phone, operates using radio signals, wireless and landline networks as well as user-programmed functions, which cannot guarantee connection in all conditions. Therefore, you should never rely solely on any wireless phone for essential communications (medical emergencies, for example).

Remember, to make or receive any calls the phone must be switched on and in a service area with adequate signal strength. Emergency calls may not be possible on all wireless phone networks or when certain network services and/or phone features are in use. Check with local service providers.

To make an emergency call:

1. If the phone is not on, switch it on.
2. Key in the emergency number for your present location (for example, 911 or other official emergency number).  
Emergency numbers vary by location.
3. Press the  key.

If certain features are in use (call barring, for example), you may first need to deactivate those features before you can make an emergency call. Consult this document and your local cellular service provider.

When making an emergency call, remember to give all the necessary information as accurately as possible.

Remember that your phone may be the only means of communication at the scene of an accident; do not cut off the call until given permission to do so.

## Other Important Safety Information

---

- Only qualified personnel should service the phone or install the phone in a vehicle. Faulty installation or service may be dangerous and may invalidate any warranty applicable to the device.
- Check regularly that all wireless phone equipment in your vehicle is mounted and operating properly.
- Do not store or carry flammable liquids, gases or explosive materials in the same compartment as the phone, its parts or accessories.
- For vehicles equipped with an air bag, remember that an air bag inflates with great force. Do not place objects, including both installed or portable wireless equipment in the area over the air bag or in the air bag deployment area. If wireless equipment is improperly installed and the air bag inflates, serious injury could result.
- Switch your phone off before boarding an aircraft. The use of wireless phones in aircraft is illegal and may be dangerous to the aircraft's operation.
- Failure to observe these instructions may lead to the suspension or denial of telephone services to the offender, or legal action, or both.

## Care and Maintenance

---

Your phone is a product of superior design and craftsmanship and should be treated with care. The suggestions below will help you fulfill any warranty obligations and allow you to enjoy this product for many years

- Keep the phone and all its parts and accessories out of the reach of small children's.
- Keep the phone dry. Precipitation, humidity and liquids contain minerals that will corrode electronic circuits.
- Do not use the phone with a wet hand. Doing so may cause an electric shock to you or damage to the phone.
- Do not use or store the phone in dusty, dirty areas, as its moving parts may be damaged.
- Do not store the phone in hot areas. High temperatures can shorten the life of electronic devices, damage batteries, and warp or melt certain plastics.
- Do not store the phone in cold areas. When the phone warms up to its normal operating temperature, moisture can form inside the phone, which may damage the phone's electronic circuit boards.
- Do not drop, knock or shake the phone. Rough handling can break internal circuit boards.
- Do not use harsh chemicals, cleaning solvents or strong detergents to clean the phone. Wipe it with a soft cloth slightly dampened in a mild soap-and-water solution.

- Do not paint the phone. Paint can clog the device's moving parts and prevent proper operation.
- Do not put the phone in or on heating devices, such as a microwave oven, a stove or a radiator. The phone may explode when overheated.
- Use only the supplied or an approved replacement antenna. Unauthorized antennas or modified accessories may damage the phone and violate regulations governing radio devices.
- If the phone, battery, charger or any accessory is not working properly, take it to your nearest qualified service facility. The personnel there will assist you, and if necessary, arrange for service.





# Glossary

To help you understand the main technical terms and abbreviations used in this booklet and take full advantage of the features on your mobile phone, here are a few definitions.

## **Active Folder**

Ability to answer a call simply by opening the phone.

## **Call Forwarding**

Ability to reroute calls to another number.

## **Call Holding**

Ability to put one call on standby while answering or making another call; you can then switch between the two calls, as required.

## **Call Waiting**

Ability to inform users that they have an incoming call when engaged on another call.

## **GSM (Global System for Mobile Communication)**

International standard for cellular communication, guaranteeing compatibility between the various network operators. GSM covers most European countries and many other parts of the world.

## **Line Identification Services (Caller ID)**

Services allowing subscribers to view or block the telephone numbers of callers.

141

## **MMS (Multimedia Message Service)**

A message service for the mobile environment, standardized by the WAP Forum and the 3rd Generation Partnership Program (3GPP). For phone users, MMS is similar to Short Message Service (SMS)-it provides automatic, immediate delivery of user-created content from phone to phone. The message addressing used is primarily phone numbers, thus the traffic goes from phone to phone. MMS also provides support for e-mail addressing, so that messages can also be sent by e-mail. In addition to the text content of SMS, MMS messages can contain still images, voice or audio clips, and later also video clips and presentation information.

## **Multiparty Calling**

Ability to establish a conference call involving up to five additional parties.

## **Phone Password**

Security code used to unlock the phone when you have selected the option to lock it automatically each time it switches on.

## **PIN (Personal Identification Number)**

Security code that protects the phone/SIM against unauthorized use. The PIN is supplied by the service provider with the SIM card. It may be a four to eight-digit number and can be changed, as required.

## **PUK (PIN Unblocking Key)**

Security code used to unlock the phone when an incorrect PIN has been entered three times in succession. The

eight-digit number is supplied by the service provider with the SIM card.

### **Roaming**

Use of your phone when you are outside your home area (when traveling for example).

### **SDN (Service Dialling Numbers)**

Telephone numbers supplied by your network provider and giving access to special services, such as voice mail, directory inquiries, customer support and emergency services.

### **SIM (Subscriber Identification Module)**

Card containing a chip with all the information required to operate the phone (network and memory information, as well as the subscriber's personal data). The SIM card fits into a small slot on the back of the phone and is protected by the battery.

### **SMS (Short Message Service)**

Network service sending and receiving messages to and from another subscriber without having to speak to the correspondent. The message created or received can be displayed, received, edited or sent.

### **Soft Keys**

Two keys marked and on the phone, the purpose of which:

- varies according to the function that you are currently using
- is indicated on the bottom line of the display just above the corresponding key

### **Dual Band**

Ability to handle any of the following types of network: GSM 850 and GSM 1900 MHz bands, for greater call success and wider roaming.

### **Voice Mail**

Computerized answering service that automatically answers your calls when you are not available, plays a greeting (optionally in your own voice) and records a message.

## Appendix A: Certification Information (SAR)

THIS MODEL PHONE MEETS THE GOVERNMENT'S REQUIREMENTS FOR EXPOSURE TO RADIO WAVES. Your wireless phone is a radio transmitter and receiver. It is designed and manufactured not to exceed the emission limits for exposure to radio frequency (RF) energy set by the Federal Communications Commission of the U.S. Government. These limits are part of comprehensive guidelines and establish permitted levels of RF energy for the general population. The guidelines are based on safety standards that were developed by independent scientific organizations through periodic and thorough evaluation of scientific studies. The standards include a substantial safety margin designed to assure the safety of all persons, regardless of age and health.

The exposure standard for wireless mobile phones employs a unit of measurement known as the Specific Absorption Rate (SAR). The SAR limit set by the FCC is 1.6 W/kg. SAR Tests are conducted using standard operating positions accepted by the FCC with the phone transmitting at its highest certified power level in all tested frequency bands. Although the SAR is determined at the highest certified power level, the actual SAR level of the phone while operating can be well below the maximum value. This is because the phone is designed to operate at multiple power levels so as to use only the power required to reach the network. In general, the closer you are to a wireless base station antenna, the lower the power output.

Before a new model phone is available for sale to the public, it must be tested and certified to the FCC that it does not exceed the limit established by the government-adopted requirement for safe exposure. The tests are performed in positions and locations (e.g., at the ear and worn on the body) as required by the FCC for each model. The highest SAR values for this model phone as reported to the FCC are Head: 1.13 W/Kg, Body-worn: 0.433 W/Kg. Body-worn operations are restricted to Samsung-supplied, approved or none Samsung designated accessories that have no metal and must provide at least 1.5cm separation between the device, including its antenna whether extended or retracted, and the user's body. Non-compliance to the above restrictions may violate FCC RF exposure guidelines.

The FCC has granted an Equipment Authorization for this model phone with all reported SAR levels evaluated as in compliance with the FCC RF exposure guidelines. SAR information on this model phone is on file with the FCC and can be found under the Display Grant section of <http://www.fcc.gov/oet/fccid> after searching on FCC ID A3LSGHP107.

In the United States and Canada, the SAR limit for mobile phones used by the public is 1.6 watts/kilogram (W/kg) averaged over one gram of tissue. The standard incorporates a substantial margin of safety to give additional protection for the public and to account for any variations in measurements.

# Appendix B: Guide to Safe and Responsible Wireless Phone Use

Cellular Telecommunications & Internet Association  
“Safety is the most important call you will ever make.”

## **A Guide to Safe and Responsible Wireless Phone Use**

TENS OF MILLIONS OF PEOPLE IN THE U.S. TODAY TAKE ADVANTAGE OF THE UNIQUE COMBINATION OF CONVENIENCE, SAFETY AND VALUE DELIVERED BY THE WIRELESS TELEPHONE. QUITE SIMPLY, THE WIRELESS PHONE GIVES PEOPLE THE POWERFUL ABILITY TO COMMUNICATE BY VOICE-ALMOST ANYWHERE, ANYTIME-WITH THE BOSS, WITH A CLIENT, WITH THE KIDS, WITH EMERGENCY PERSONNEL OR EVEN WITH THE POLICE. EACH YEAR, AMERICANS MAKE BILLIONS OF CALLS FROM THEIR WIRELESS PHONES, AND THE NUMBERS ARE RAPIDLY GROWING.

But an important responsibility accompanies those benefits, one that every wireless phone user must uphold. When driving a car, driving is your first responsibility. A wireless phone can be an invaluable tool, but good judgment must be exercised at all times while driving a motor vehicle-whether on the phone or not.

The basic lessons are ones we all learned as teenagers. Driving requires alertness, caution and courtesy. It requires a heavy dose of basic common sense-keep your head up, keep your eyes on the road, check your mirrors



frequently and watch out for other drivers. It requires obeying all traffic signs and signals and staying within the speed limit.

It means using seat belts and requiring other passengers to do the same.

But with wireless phone use, driving safely means a little more. This brochure is a call to wireless phone users everywhere to make safety their first priority when behind the wheel of a car. Wireless telecommunications is keeping us in touch, simplifying our lives, protecting us in emergencies and providing opportunities to help others in need. When it comes to the use of wireless phones, safety is your most important call.

### **Wireless Phone “Safety Tips”**

Below are safety tips to follow while driving and using a wireless phone which should be easy to remember:

1. Get to know your wireless phone and its features such as speed dial and redial. Carefully read your instruction manual and learn to take advantage of valuable features most phones offer, including automatic redial and memory. Also, work to memorize the phone keypad so you can use the speed dial function without taking your attention off the road.
2. When available, use a hands free device. A number of hands free wireless phone accessories are readily available today. Whether you choose an installed mounted device for your wireless phone or a speaker phone accessory, take advantage of these devices if available to you.

3. Position your wireless phone within easy reach. Make sure you place your wireless phone within easy reach and where you can grab it without removing your eyes from the road. If you get an incoming call at an inconvenient time, if possible, let your voice mail answer it for you.
4. Suspend conversations during hazardous driving conditions or situations. Let the person you are speaking with know you are driving; if necessary, suspend the call in heavy traffic or hazardous weather conditions. Rain, sleet, snow and ice can be hazardous, but so is heavy traffic. As a driver, your first responsibility is to pay attention to the road.
5. Do not take notes or look up phone numbers while driving. If you are reading an address book or business card, or writing a “to do” list while driving a car, you are not watching where you are going. It’s common sense. Don’t get caught in a dangerous situation because you are reading or writing and not paying attention to the road or nearby vehicles.
6. Dial sensibly and assess the traffic; if possible, place calls when you are not moving or before pulling into traffic. Try to plan your calls before you begin your trip or attempt to coincide your calls with times you may be stopped at a stop sign, red light or otherwise stationary. But if you need to dial while driving, follow this simple tip-dial only a few numbers, check the road and your mirrors, then continue.
7. Do not engage in stressful or emotional conversations that may be distracting. Stressful or emotional

conversations and driving do not mix-they are distracting and even dangerous when you are behind the wheel of a car. Make people you are talking with aware you are driving and if necessary, suspend conversations which have the potential to divert your attention from the road.

8. Use your wireless phone to call for help. Your wireless phone is one of the greatest tools you can own to protect yourself and your family in dangerous situations-with your phone at your side, help is only three numbers away. Dial 9-1-1 or other local emergency number in the case of fire, traffic accident, road hazard or medical emergency. Remember, it is a free call on your wireless phone!
9. Use your wireless phone to help others in emergencies. Your wireless phone provides you a perfect opportunity to be a “Good Samaritan” in your community. If you see an auto accident, crime in progress or other serious emergency where lives are in danger, call 9-1-1 or other local emergency number, as you would want others to do for you.
10. Call roadside assistance or a special wireless non-emergency assistance number when necessary. Certain situations you encounter while driving may require attention, but are not urgent enough to merit a call for emergency services. But you still can use your wireless phone to lend a hand. If you see a broken-down vehicle posing no serious hazard, a broken traffic signal, a minor traffic accident where no one appears injured or a vehicle you know to be stolen, call roadside

assistance or other special non-emergency wireless number.

Careless, distracted individuals and people driving irresponsibly represent a hazard to everyone on the road. Since 1984, the Cellular Telecommunications Industry Association and the wireless industry have conducted educational outreach to inform wireless phone users of their responsibilities as safe drivers and good citizens. As we approach a new century, more and more of us will take advantage of the benefits of wireless telephones. And, as we take to the roads, we all have a responsibility to drive safely.

“The wireless industry reminds you to use your phone safely when driving.”

Cellular Telecommunications & Internet Association  
For more information, please call 1-888-901-SAFE. For updates:

<http://www.wow-com.com/consumer/issues/driving/articles.cfm?ID=85>



# Appendix C: Consumer Update on Wireless Phones

## U.S. Food and Drug Administration

### 1. What kinds of phones are the subject of this update?

The term wireless phone refers here to hand-held wireless phones with built-in antennas, often called cell, mobile, or PCS phones. These types of wireless phones can expose the user to measurable radio frequency energy (RF) because of the short distance between the phone and the user's head. These RF exposures are limited by Federal Communications Commission safety guidelines that were developed with the advice of FDA and other federal health and safety agencies. When the phone is located at greater distances from the user, the exposure to RF is drastically lower because a person's RF exposure decreases rapidly with increasing distance from the source. The so-called "cordless phones," which have a base unit connected to the telephone wiring in a house, typically operate at far lower power levels, and thus produce RF exposures well within the FCC's compliance limits.

### 2. Do wireless phones pose a health hazard?

The available scientific evidence does not show that any health problems are associated with using wireless phones. There is no proof, however, that wireless phones are absolutely safe. Wireless phones emit low levels of radio frequency energy (RF) in the microwave range while being used. They also emit very low levels of RF when in the stand-by mode. Whereas high levels of RF can

produce health effects (by heating tissue), exposure to low level RF that does not produce heating effects causes no known adverse health effects. Many studies of low level RF exposures have not found any biological effects. Some studies have suggested that some biological effects may occur, but such findings have not been confirmed by additional research. In some cases, other researchers have had difficulty in reproducing those studies, or in determining the reasons for inconsistent results.

### 3. What is FDA's role concerning the safety of wireless phones?

Under the law, FDA does not review the safety of radiation-emitting consumer products such as wireless phones before they can be sold, as it does with new drugs or medical devices. However, the agency has authority to take action if wireless phones are shown to emit radio frequency energy (RF) at a level that is hazardous to the user. In such a case, FDA could require the manufacturers of wireless phones to notify users of the health hazard and to repair, replace or recall the phones so that the hazard no longer exists.

Although the existing scientific data do not justify FDA regulatory actions, FDA has urged the wireless phone industry to take a number of steps, including the following:

- Support needed research into possible biological effects of RF of the type emitted by wireless phones;
- Design wireless phones in a way that minimizes any RF exposure to the user that is not necessary for device function; and

Cooperate in providing users of wireless phones with the best possible information on possible effects of wireless phone use on human health

FDA belongs to an interagency working group of the federal agencies that have responsibility for different aspects of RF safety to ensure coordinated efforts at the federal level. The following agencies belong to this working group:

National Institute for Occupational Safety and Health

Environmental Protection Agency

Federal Communications Commission

Occupational Safety and Health Administration

National Telecommunications and Information Administration

The National Institutes of Health participates in some interagency working group activities, as well.

FDA shares regulatory responsibilities for wireless phones with the Federal Communications Commission (FCC). All phones that are sold in the United States must comply with FCC safety guidelines that limit RF exposure. FCC relies on FDA and other health agencies for safety questions about wireless phones.

FCC also regulates the base stations that the wireless phone networks rely upon. While these base stations operate at higher power than do the wireless phones themselves, the RF exposures that people get from these base stations are typically thousands of times lower than those they can get from wireless phones. Base stations are thus not the primary subject of the safety questions discussed in this document.



#### 4. What is FDA doing to find out more about the possible health effects of wireless phone RF?

FDA is working with the U.S. National Toxicology Program and with groups of investigators around the world to ensure that high priority animal studies are conducted to address important questions about the effects of exposure to radio frequency energy (RF).

FDA has been a leading participant in the World Health Organization International Electromagnetic Fields (EMF) Project since its inception in 1996. An influential result of this work has been the development of a detailed agenda of research needs that has driven the establishment of new research programs around the world. The Project has also helped develop a series of public information documents on EMF issues.

FDA and the Cellular Telecommunications & Internet Association (CTIA) have a formal Cooperative Research and Development Agreement (CRADA) to do research on wireless phone safety. FDA provides the scientific oversight, obtaining input from experts in government, industry, and academic organizations. CTIA-funded research is conducted through contracts to independent investigators. The initial research will include both laboratory studies and studies of wireless phone users. The CRADA will also include a broad assessment of additional research needs in the context of the latest research developments around the world.

#### 5. What steps can I take to reduce my exposure to radio frequency energy from my wireless phone?

If there is a risk from these products—and at this point we do not know that there is—it is probably very small. But if you are concerned about avoiding even potential risks, you can take a few simple steps to minimize your exposure to radio frequency energy (RF). Since time is a key factor in how much exposure a person receives, reducing the amount of time spent using a wireless phone will reduce RF exposure.

If you must conduct extended conversations by wireless phone every day, you could place more distance between your body and the source of the RF, since the exposure level drops off dramatically with distance. For example, you could use a headset and carry the wireless phone away from your body or use a wireless phone connected to a remote antenna

Again, the scientific data do not demonstrate that wireless phones are harmful. But if you are concerned about the RF exposure from these products, you can use measures like those described above to reduce your RF exposure from wireless phone use.

## 6. What about children using wireless phones?

The scientific evidence does not show a danger to users of wireless phones, including children and teenagers. If you want to take steps to lower exposure to radio frequency energy (RF), the measures described above would apply to children and teenagers using wireless phones. Reducing the time of wireless phone use and increasing the distance between the user and the RF source will reduce RF exposure.

Some groups sponsored by other national governments have advised that children be discouraged from using wireless phones at all. For example, the government in the United Kingdom distributed leaflets containing such a recommendation in December 2000. They noted that no evidence exists that using a wireless phone causes brain tumors or other ill effects. Their recommendation to limit wireless phone use by children was strictly precautionary; it was not based on scientific evidence that any health hazard exists.

7. Do hands-free kits for wireless phones reduce risks from exposure to RF emissions?

Since there are no known risks from exposure to RF emissions from wireless phones, there is no reason to believe that hands-free kits reduce risks. Hands-free kits can be used with wireless phones for convenience and comfort. These systems reduce the absorption of RF energy in the head because the phone, which is the source of the RF emissions, will not be placed against the head. On the other hand, if the phone is mounted against the waist or other part of the body during use, then that part of the body will absorb more RF energy. Wireless phones marketed in the U.S. are required to meet safety requirements regardless of whether they are used against the head or against the body. Either configuration should result in compliance with the safety limit.

8. Do wireless phone accessories that claim to shield the head from RF radiation work?

Since there are no known risks from exposure to RF emissions from wireless phones, there is no reason to

believe that accessories that claim to shield the head from those emissions reduce risks. Some products that claim to shield the user from RF absorption use special phone cases, while others involve nothing more than a metallic accessory attached to the phone. Studies have shown that these products generally do not work as advertised. Unlike “hand-free” kits, these so-called “shields” may interfere with proper operation of the phone. The phone may be forced to boost its power to compensate, leading to an increase in RF absorption. In February 2002, the Federal Trade Commission (FTC) charged two companies that sold devices that claimed to protect wireless phone users from radiation with making false and unsubstantiated claims. According to FTC, these defendants lacked a reasonable basis to substantiate their claim.

#### 9. What about wireless phone interference with medical equipment?

Radio frequency energy (RF) from wireless phones can interact with some electronic devices. For this reason, FDA helped develop a detailed test method to measure electromagnetic interference (EMI) of implanted cardiac pacemakers and defibrillators from wireless telephones. This test method is now part of a standard sponsored by the Association for the Advancement of Medical Instrumentation (AAMI). The final draft, a joint effort by FDA, medical device manufacturers, and many other groups, was completed in late 2000. This standard will allow manufacturers to ensure that cardiac pacemakers and defibrillators are safe from wireless phone EMI. FDA has tested hearing aids for interference from handheld wireless phones and helped develop a voluntary

standard sponsored by the Institute of Electrical and Electronic Engineers (IEEE). This standard specifies test methods and performance requirements for hearing aids and wireless phones so that no interference occurs when a person uses a compatible phone and a compatible hearing aid at the same time. This standard was approved by the IEEE in 2000.

FDA continues to monitor the use of wireless phones for possible interactions with other medical devices. Should harmful interference be found to occur, FDA will conduct testing to assess the interference and work to resolve the problem.

#### 10. What are the results of the research done already?

The research done thus far has produced conflicting results, and many studies have suffered from flaws in their research methods. Animal experiments investigating the effects of radio frequency energy (RF) exposures characteristic of wireless phones have yielded conflicting results that often cannot be repeated in other laboratories. A few animal studies, however, have suggested that low levels of RF could accelerate the development of cancer in laboratory animals. However, many of the studies that showed increased tumor development used animals that had been genetically engineered or treated with cancer-causing chemicals so as to be pre-disposed to develop cancer in the absence of RF exposure. Other studies exposed the animals to RF for up to 22 hours per day. These conditions are not similar to the conditions under which people use wireless phones, so we don't know with certainty what the results of such studies mean for human health.

Three large epidemiology studies have been published since December 2000. Between them, the studies investigated any possible association between the use of wireless phones and primary brain cancer, glioma, meningioma, or acoustic neuroma, tumors of the brain or salivary gland, leukemia, or other cancers. None of the studies demonstrated the existence of any harmful health effects from wireless phone RF exposures. However, none of the studies can answer questions about long-term exposures, since the average period of phone use in these studies was around three years.

#### 11. What research is needed to decide whether RF exposure from wireless phones poses a health risk?

A combination of laboratory studies and epidemiological studies of people actually using wireless phones would provide some of the data that are needed. Lifetime animal exposure studies could be completed in a few years. However, very large numbers of animals would be needed to provide reliable proof of a cancer promoting effect if one exists. Epidemiological studies can provide data that is directly applicable to human populations, but 10 or more years follow-up may be needed to provide answers about some health effects, such as cancer. This is because the interval between the time of exposure to a cancer-causing agent and the time tumors develop - if they do - may be many, many years. The interpretation of epidemiological studies is hampered by difficulties in measuring actual RF exposure during day-to-day use of wireless phones. Many factors affect this measurement, such as the angle at which the phone is held, or which model of phone is used.

12. Which other federal agencies have responsibilities related to potential RF health effects?

Additional information on the safety of RF exposures from various sources can be obtained from the following organizations.

FCC RF Safety Program:

<http://www.fcc.gov/oet/rfsafety/>

Environmental Protection Agency (EPA):

<http://www.epa.gov/radiation/>

Occupational Safety and Health Administration's (OSHA):

<http://www.osha-slc.gov/SLTC/radiofrequencyradiation/index.html>

National Institute for Occupational Safety and Health (NIOSH):

<http://www.cdc.gov/niosh/emfpg.html>

World Health Organization (WHO):

<http://www.who.int/peh-emf/>

International Commission on Non-Ionizing Radiation Protection:

<http://www.icnirp.de>

National Radiation Protection Board (UK):

<http://www.nrpb.org.uk>

Updated 4/3/2002: US Food and Drug Administration

<http://www.fda.gov/cellphones>

# Standard Limited Warranty

**What is Covered and For How Long?** SAMSUNG TELECOMMUNICATIONS AMERICA, L.P. (“SAMSUNG”) warrants to the original purchaser (“Purchaser”) that SAMSUNG’s Phones and accessories (“Products”) are free from defects in material and workmanship under normal use and service for the period commencing upon the date of purchase and continuing for the following specified period of time after that date:

|                         |         |
|-------------------------|---------|
| Phone                   | 1 Year  |
| Batteries               | 1 Year  |
| Leather Case/ Pouch     | 90 Days |
| Holster                 | 90 Days |
| Other Phone Accessories | 1 Year  |

**What is Not Covered?** This Limited Warranty is conditioned upon proper use of Product by Purchaser. This Limited Warranty does not cover: (a) defects or damage resulting from accident, misuse, abuse, neglect, unusual physical, electrical or electromechanical stress, or modification of any part of Product, including antenna, or cosmetic damage; (b) equipment that has the serial number removed or made illegible; (c) any plastic surfaces or other externally exposed parts that are scratched or damaged due to normal use; (d) malfunctions resulting from the use of Product in conjunction with accessories, products, or ancillary/peripheral equipment not furnished or approved by SAMSUNG; (e) defects or damage from improper testing, operation, maintenance, installation, or adjustment; (f) installation, maintenance, and service of Product, or (g) Product used or purchased outside the



United States or Canada. This Limited Warranty covers batteries only if battery capacity falls below 80% of rated capacity or the battery leaks, and this Limited Warranty does not cover any battery if (i) the battery has been charged by a battery charger not specified or approved by SAMSUNG for charging the battery, (ii) any of the seals on the battery are broken or show evidence of tampering, or (iii) the battery has been used in equipment other than the SAMSUNG phone for which it is specified.

**What are SAMSUNG's Obligations?** During the applicable warranty period, SAMSUNG will repair or replace, at SAMSUNG's sole option, without charge to Purchaser, any defective component part of Product. To obtain service under this Limited Warranty, Purchaser must return Product to an authorized phone service facility in an adequate container for shipping, accompanied by Purchaser's sales receipt or comparable substitute proof of sale showing the date of purchase, the serial number of Product and the sellers' name and address. To obtain assistance on where to deliver the Product, call Samsung Customer Care at 1-888-987-4357. Upon receipt, SAMSUNG will promptly repair or replace the defective Product. SAMSUNG may, at SAMSUNG's sole option, use rebuilt, reconditioned, or new parts or components when repairing any Product or replace Product with a rebuilt, reconditioned or new Product. Repaired/replaced leather cases, pouches and holsters will be warranted for a period of ninety (90) days. All other repaired/replaced Product will be warranted for a period equal to the remainder of the original Limited Warranty on the original Product or for 90 days, whichever is longer. All replaced parts, components, boards and equipment shall become the property of

**SAMSUNG.** If SAMSUNG determines that any Product is not covered by this Limited Warranty, Purchaser must pay all parts, shipping, and labor charges for the repair or return of such Product.

**What Are the Limits On SAMSUNG's Liability?** EXCEPT AS SET FORTH IN THE EXPRESS WARRANTY CONTAINED HEREIN, PURCHASER TAKES THE PRODUCT "AS IS," AND SAMSUNG MAKES NO WARRANTY OR REPRESENTATION AND THERE ARE NO CONDITIONS, EXPRESS OR IMPLIED, STATUTORY OR OTHERWISE, OF ANY KIND WHATSOEVER WITH RESPECT TO THE PRODUCT, INCLUDING BUT NOT LIMITED TO:

- ◆ THE MERCHANTABILITY OF THE PRODUCT OR ITS FITNESS FOR ANY PARTICULAR PURPOSE OR USE;
- ◆ WARRANTIES OF TITLE OR NON-INFRINGEMENT;
- ◆ DESIGN, CONDITION, QUALITY, OR PERFORMANCE OF THE PRODUCT;
- ◆ THE WORKMANSHIP OF THE PRODUCT OR THE COMPONENTS CONTAINED THEREIN; OR
- ◆ COMPLIANCE OF THE PRODUCT WITH THE REQUIREMENTS OF ANY LAW, RULE, SPECIFICATION OR CONTRACT PERTAINING THERETO.

NOTHING CONTAINED IN THE INSTRUCTION MANUAL SHALL BE CONSTRUED TO CREATE AN EXPRESS WARRANTY OF ANY KIND WHATSOEVER WITH RESPECT TO THE PRODUCT. ALL IMPLIED WARRANTIES AND CONDITIONS THAT MAY ARISE BY OPERATION OF LAW, INCLUDING IF APPLICABLE THE IMPLIED WARRANTIES OF MERCHANTABILITY AND

FITNESS FOR A PARTICULAR PURPOSE, ARE HEREBY LIMITED TO THE SAME DURATION OF TIME AS THE EXPRESS WRITTEN WARRANTY STATED HEREIN. SOME STATES/PROVINCES DO NOT ALLOW LIMITATIONS ON HOW LONG AN IMPLIED WARRANTY LASTS, SO THE ABOVE LIMITATION MAY NOT APPLY TO YOU. IN ADDITION, SAMSUNG SHALL NOT BE LIABLE FOR ANY DAMAGES OF ANY KIND RESULTING FROM THE PURCHASE, USE, OR MISUSE OF, OR INABILITY TO USE THE PRODUCT OR ARISING DIRECTLY OR INDIRECTLY FROM THE USE OR LOSS OF USE OF THE PRODUCT OR FROM THE BREACH OF THE EXPRESS WARRANTY, INCLUDING INCIDENTAL, SPECIAL, CONSEQUENTIAL OR SIMILAR DAMAGES, OR LOSS OF ANTICIPATED PROFITS OR BENEFITS, OR FOR DAMAGES ARISING FROM ANY TORT (INCLUDING NEGLIGENCE OR GROSS NEGLIGENCE) OR FAULT COMMITTED BY SAMSUNG, ITS AGENTS OR EMPLOYEES, OR FOR ANY BREACH OF CONTRACT OR FOR ANY CLAIM BROUGHT AGAINST PURCHASER BY ANY OTHER PARTY. SOME STATES/PROVINCES DO NOT ALLOW THE EXCLUSION OR LIMITATION OF INCIDENTAL OR CONSEQUENTIAL DAMAGES, SO THE ABOVE LIMITATION OR EXCLUSION MAY NOT APPLY TO YOU. THIS WARRANTY GIVES YOU SPECIFIC LEGAL RIGHTS, AND YOU MAY ALSO HAVE OTHER RIGHTS, WHICH VARY FROM STATE TO STATE/PROVINCE TO PROVINCE. THIS LIMITED WARRANTY SHALL NOT EXTEND TO ANYONE OTHER THAN THE ORIGINAL PURCHASER OF THIS PRODUCT AND STATES

PURCHASER'S EXCLUSIVE REMEDY. IF ANY PORTION OF THIS LIMITED WARRANTY IS HELD ILLEGAL OR UNENFORCEABLE BY REASON OF ANY LAW, SUCH PARTIAL ILLEGALITY OR UNENFORCEABILITY SHALL NOT AFFECT THE ENFORCEABILITY FOR THE REMAINDER OF THIS LIMITED WARRANTY WHICH PURCHASER ACKNOWLEDGES IS AND WILL ALWAYS BE CONSTRUED TO BE LIMITED BY ITS TERMS OR AS LIMITED AS THE LAW PERMITS.

THE PARTIES UNDERSTAND THAT THE PURCHASER MAY USE THIRD-PARTY SOFTWARE OR EQUIPMENT IN CONJUNCTION WITH THE PRODUCT. SAMSUNG MAKES NO WARRANTIES OR REPRESENTATIONS AND THERE ARE NO CONDITIONS, EXPRESS OR IMPLIED, STATUTORY OR OTHERWISE, AS TO THE QUALITY, CAPABILITIES, OPERATIONS, PERFORMANCE OR SUITABILITY OF ANY THIRD-PARTY SOFTWARE OR EQUIPMENT, WHETHER SUCH THIRD-PARTY SOFTWARE OR EQUIPMENT IS INCLUDED WITH THE PRODUCT DISTRIBUTED BY SAMSUNG OR OTHERWISE, INCLUDING THE ABILITY TO INTEGRATE ANY SUCH SOFTWARE OR EQUIPMENT WITH THE PRODUCT. THE QUALITY, CAPABILITIES, OPERATIONS, PERFORMANCE AND SUITABILITY OF ANY SUCH THIRD-PARTY SOFTWARE OR EQUIPMENT LIE SOLELY WITH THE PURCHASER AND THE DIRECT VENDOR, OWNER OR SUPPLIER OF SUCH THIRD-PARTY SOFTWARE OR EQUIPMENT, AS THE CASE MAY BE.

This Limited Warranty allocates risk of Product failure between Purchaser and SAMSUNG, and SAMSUNG's

Product pricing reflects this allocation of risk and the limitations of liability contained in this Limited Warranty. The agents, employees, distributors, and dealers of SAMSUNG are not authorized to make modifications to this Limited Warranty, or make additional warranties binding on SAMSUNG. Accordingly, additional statements such as dealer advertising or presentation, whether oral or written, do not constitute warranties by SAMSUNG and should not be relied upon.

Samsung Telecommunications America, L.P.

1301 East Lookout Dr.

Richardson, Texas 75081

Phone: 1-800-SAMSUNG

Phone: 1-888-987-HELP (4357)

©2002 Samsung Telecommunications America. All rights reserved.

No reproduction in whole or in part allowed without prior written approval.

Specifications and availability subject to change without notice.

# Index

## A

- Accessories •, 13
- Active Flip •, 108
- Alarm (5.4) •, 119
- Alert type (3.3) •, 95
- Answering
  - a call •, 32
  - a second call •, 60
- Anykey Answer •, 108
- Auto Power •, 118
- Auto redial (4.5), 108

## B

- Background Image •, 100
- Backlight •, 21
- Battery
  - charging •, 25
  - low battery indicator •, 27
  - precautions •, 147
- Browser, WAP (7.2) •, 129

## C

- Calculator (5.5) •, 119
- Calendar (5.1) •, 111
- Caller ID (7.4) •, 126
- Calls
  - answering
    - a call •, 32
    - a second call •, 60
  - dialled (2.3) •, 92
  - ending •, 30
  - holding •, 57
  - international •, 29
  - missed •, 33, 91
  - multiparty •, 61
  - redialling automatically •,

- 108
- time (2.4) •, 92
- via phonebook •, 45
- waiting (6.3) •, 60
- waiting•, 124

## Changing

- password (4.6.4) •, 104
- PIN (4.6.2) •, 103
- PIN2 (4.6.7) •, 105

## Characters

- changing mode •, 51

## Charging battery •, 25

- Colour Theme •, 101
- Conference call •, 61

## Connect

- tone •, 98

## Copying

- memos •, 113
- phonebook number •, 45
- task •, 116

## Correcting numbers •, 30

## Currency Exchange (5.6) •, 119

## D

## Date setting (5.3.2) •, 117

## Deleting

- memos •, 113
- messages •, 74
- missed calls •, 34
- phonebook number •, 44
- tasks •, 116

## Dialled calls (2.3) •, 92

## Display

- icons •, 20
- setting language •, 102

## Display Settings, 106

## Downloads (7.3) •, 135

## E

Earpiece volume •, 31

### Editing

- memos •, 112
- messages •, 74, 75
- missed calls •, 33
- phonebook number •, 44
- tasks •, 115
- to do list •, 114

Emergency calls •, 154

Error tone •, 98

## F

FDN mode (4.6.6) •, 105

Fixed Dial Number mode •, 105

## G

Greeting message (4.3) •, 102

## H

Holding calls •, 57

## I

### Icons

- description •, 20

Identifying a caller •, 32

## K

### Key tones

- adjusting volume •, 32
- muting •, 59
- selecting (3.4) •, 96
- sending •, 59

Keypad tone (3.4) •, 96

### Keys

- description •, 16
- shortcut •, 108

## L

Language (4.5) •, 102

Last number, redial •, 30

Length of calls •, 92, 98

## Letters

- changing mode •, 51

### Light

- backlight •, 21
- service •, 22

### Locking

- SIM card (4.6.5) •, 105

Low battery indicator •, 27

### Lower-case characters

- entering •, 53

## M

### Memory Status

- phonebook •, 50

### Memos

- copying •, 113
- deleting •, 113
- editing •, 112
- writing •, 119

### Menus

- accessing by scroll •, 65
- accessing by shortcuts •, 66
- list •, 66

Message tone (3.5) •, 96

### Messages

- setup (1.4) •, 78
- templates (1.3) •, 77

Microphone mute •, 58

Minute minder •, 98

Missed calls (1.1) •, 33, 91

Morning Call, 118

### Multiparty calls

- dropping •, 62
- making •, 61
- private conversation •, 62

### Muting

- key tones •, 59

microphone •, 58

## N

### Names

searching/dialling •, 45

storing •, 41

Network selection (7.3) •, 125

### Numbers

copying phonebook •, 45

correcting •, 30

erasing •, 44

fixed dial •, 105

own •, 102

pasting phonebook •, 44

searching/dialling •, 45

storing •, 41

## O

Own number (4.4) •, 102

## P

### Password

#### phone

changing •, 104

description •, 141

### Phone

care and maintenance •,  
156

password •, 141

### Phonebook

copying •, 45

editing •, 44

erasing •, 44

options •, 44

pasting •, 44

searching/dialling •, 45

speed-dialling •, 48

storing numbers/names •,  
41

## PIN

changing •, 103

checking •, 103

description •, 142

### PIN2

changing •, 105

description •, 143

PUK •, 142

PUK2 •, 143

## R

Radio-frequency •, 145

### Redialling

automatically •, 108

last number •, 30

Reset setting (4.10) •, 110

### Ring

tone (3.1) •, 95

type (3.3) •, 95

volume (3.2) •, 95

Road safety •, 149

Roaming •, 125

## S

### Safety

quick guide •, 7, 67

Schedule •, 111

Searching in phonebook •, 45

### Sending

key tones •, 59

Service light •, 22

### Setting

alarm (5.4) •, 119

date (5.3.2) •, 117

language (4.5) •, 102

time (5.3.1) •, 117

Shortcut (4.9) •, 108

### SIM card

locking •, 105

SIM Lock (4.6.5) •, 105



## SMS

- message icon •, 73
- setup •, 78
- using •, 60, 67

## Soft keys •, 37

## Speed-dialling •, 48

## Switching on/off

- microphone •, 58
- phone •, 27

## T

## T9 mode •, 52

## Tasks

- defining •, 113
- editing •, 114

## Templates (2.3) •, 77

## Text

- changing mode •, 51

## Time

- call •, 92
- format (5.3.4) •, 117
- setting (5.3.1) •, 117
- world (5.3.3) •, 117

## To do list (5.2) •, 113

## Tone

- connect •, 98
- error •, 98
- keypad •, 96
- message •, 96
- ring •, 95

## Travel adapter •, 25

## U

## Unpacking •, 8, 13

## Upper-case characters

- entering •, 53

## V

## Vibration •, 96

## Voice server •, 81

## Volume

- adjusting •, 31
- selecting the ring •, 95

## W

## Waiting

- call •, 60





## Waiting call •, 124



## WAP Browser •, 129







## World time (5.3.3) •, 117



## Writing memos •, 119







## Dual Band SGH-P107 GPRS Telephone Quick Reference Card

|                           |  |
|---------------------------|--|
| Access the Menu Functions | <ol style="list-style-type: none"><li>1 Press the <b>Menu</b> soft key.</li><li>2 Scroll with the  and  keys through the list of the menus until you reach the required menu.</li><li>3 Press the <b>Select</b> soft key.</li><li>4 Scroll with the  and  keys through the list of the options until the required one is selected.</li><li>5 Press the <b>Select</b> soft key.</li></ol> |
|---------------------------|--|

Each of the two soft keys (  and  ) perform the function indicated by the text above it, on the bottom line of the display.

|  |  |
|--|--|
| Switch On/Off                                    | Press and hold the  key.  |
| Make a Call                                      | <ol style="list-style-type: none"><li>1 Key in the number.</li><li>2 Press the  key.</li></ol>  |
| End a Call                                       | Briefly press the  key.   |
| View Missed Calls Immediately After Missing Them | <ol style="list-style-type: none"><li>1 Open the phone and press the <b>View</b> soft key.</li><li>2 Scroll with the  and  keys through the missed calls.</li><li>3 To return the call, press the  key.</li></ol> |

|                       |  |
|-----------------------|--|
| Answer a Call         | Open the phone or<br>Press the  key.  |
| Adjust the Volume     | Press the  or  key on the left side of the phone.  |
| Choose the Alert Type | <ol style="list-style-type: none"> <li>Select the <b>Alert Type</b> menu option (<b>Menu 5.4</b>).</li> <li>Select an option:<br/><b>Light only</b><br/><b>Melody</b><br/><b>Vibration</b><br/><b>Vibra+Melody</b></li> <li>Press the <b>Select</b> soft key.</li> </ol> |

|                                  |  |
|----------------------------------|--|
| Store Numbers in Phonebook       | <ol style="list-style-type: none"> <li>Enter the number.</li> <li>Press the <b>Save</b> soft key.</li> <li>Select an icon for label.</li> <li>Press the <b>Select</b> soft key.</li> <li>Enter the name.</li> <li>Press the <b>OK</b> soft key.</li> <li>If necessary, change the memory.</li> <li>Press the <b>OK</b> soft key.</li> <li>Press  to return to Idle Mode.</li> </ol>  |
| Search for a Number in Phonebook | <ol style="list-style-type: none"> <li>Press the <b>Name</b> soft key.</li> <li>Select the <b>Search</b> option.</li> <li>Enter the first few letters of the name.</li> <li>To scroll through the names, press the  or  key.</li> <li>Press the <b>View</b> soft key.</li> <li>To scroll through the numbers, press the  or  key.</li> <li>Press the  key to dial.</li> </ol> |